



# 6 FT KIDS WAVY SLIDE

MODEL# 9305WS  
PRODUCT MANUAL - VERSION 3.19.2

FOR AGES:

**3-7**

WEIGHT LIMIT:

**100** Lbs  
45.35 Kg

TO BUILD:



TO BUILD:



**HOW-TO**  
VIDEOS ONLINE

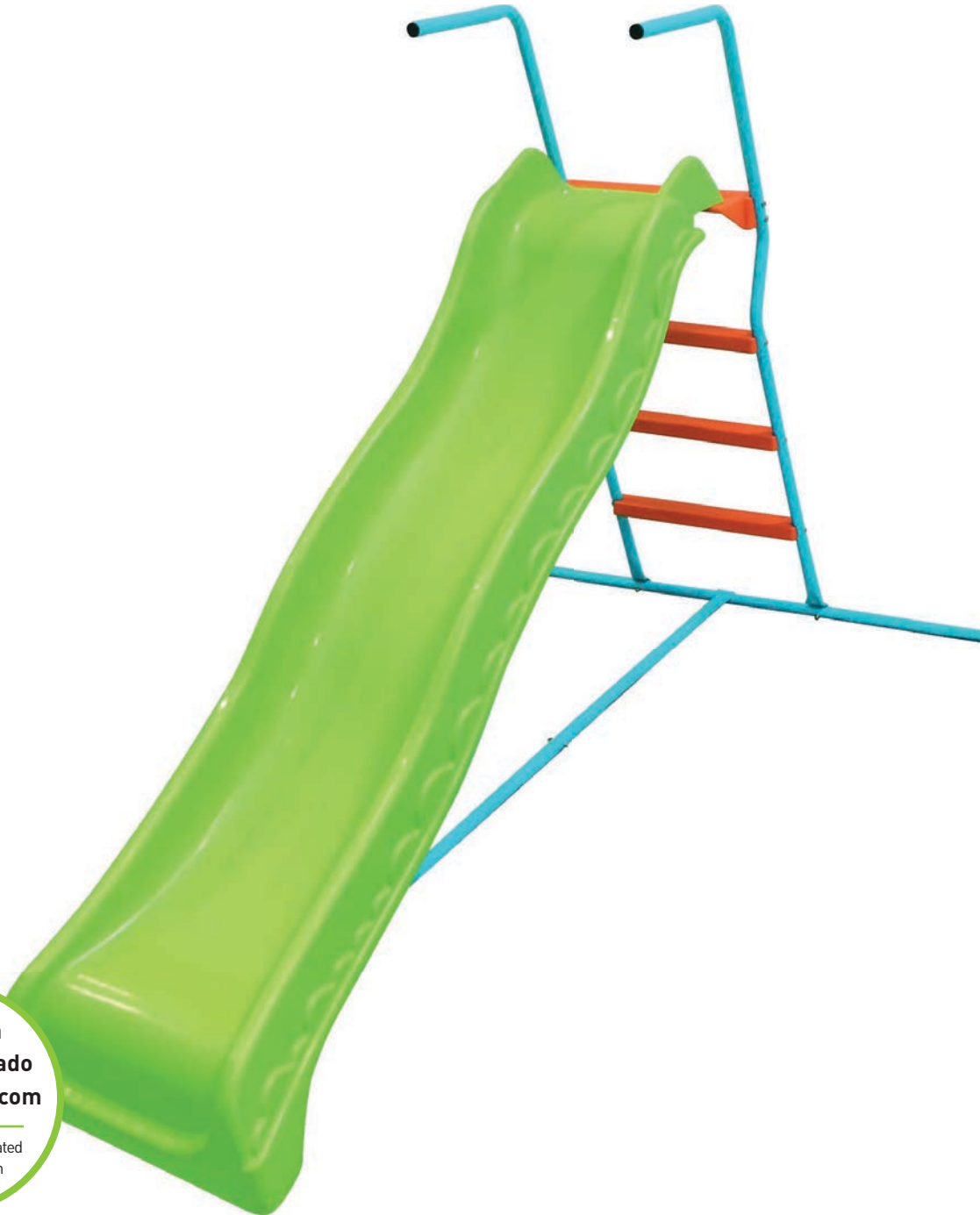

Manual en  
español ubicado  
en [GQBrands.com](http://GQBrands.com)

Spanish Manual located  
at [GQBrands.com](http://GQBrands.com)

## CUSTOMER SERVICE

[GQBrands.com](http://GQBrands.com) • [CustomerService@GQBrands.com](mailto:CustomerService@GQBrands.com) • 1-866-498-5269 • 4401 Samuell Blvd, Ste 150, Mesquite, TX 75149



# CUSTOMER SERVICE INFORMATION

## Thank you for purchasing: 6 FT KIDS WAVY SLIDE

MODEL# 9305WS

**If you have an issue with your item, do not return. Please report items that are damaged or missing parts to the manufacturer GQ Brands within three days of delivery. Contact customer service at customerservice@gqbrands.com or toll-free at 1-866-498-5269**

At GQBrands®, we want all of our customers to be completely satisfied with their purchase. Take time to review the contents of the product you have just received to make sure that all of the parts are included. If you find that any parts are missing or damaged, we will provide replacement parts at no charge within 30 days of purchase.

Please keep in mind that for select damaged part replacement requests, we will require a photo for submission.

To order these parts, or if you have any other questions or concerns about this GQBrands product, please contact us at

PureFun.Net  
GQBrands@  
Phone: 1-866-498-5269  
Email: CustomerService@GQBrands.com  
4401 Samuell Blvd, Ste 150,  
Mesquite, TX 75149

Please be sure to include the following information when you contact Customer Service:

**YOUR NAME:** \_\_\_\_\_

**YOUR MAILING ADDRESS:** \_\_\_\_\_

**YOUR EMAIL ADDRESS:** \_\_\_\_\_

**PRODUCT NAME:** \_\_\_\_\_

**PRODUCT MODEL#:** \_\_\_\_\_

**PART NUMBER** \_\_\_\_\_

**RETAILER WHERE PURCHASED:** \_\_\_\_\_

**DATE OF PURCHASE:** \_\_\_\_\_

**ORDER NUMBER:** *(If Available)* \_\_\_\_\_

**SERIAL NUMBER:** *(If Available)* \_\_\_\_\_

**QUANTITY NEEDED:** \_\_\_\_\_

**PICTURE OF DAMAGED PART**

## LIMITED WARRANTY

Global Quality Brands® warrants this product to be free from defects in workmanship and materials under normal use and conditions for a period of 90 DAYS FROM THE DATE OF ORIGINAL PURCHASE. This Limited Warranty is not transferable and is available only for the original purchaser of the Product. The Company's obligation under this warranty is limited to replacing or repairing the Product, at the discretion of the company.

All warranty coverage extends only to the original retail purchaser from the date of purchase, GQ Brands obligation under this warranty is limited to replacing or repairing, at Global Quality Brands® option. All products for which a warranty claim is made must be received by Global Quality Brands® and accompanied by sufficient proof of purchase (photocopy of the original store receipt, indicating the date of purchase). All freight and handling fees are the responsibility of the consumer to pay, both to and from Global Quality Brands®. All warranty claims must be preauthorized by Global Quality Brands® pre-authorization can be obtained by calling 866-498-5269.

This warranty does not cover ordinary wear and tear, weathering, failure to follow directions, improper installation, improper maintenance, or acts of nature, (such as damage caused by wind, lightning, snow, water, or ice) weather damage, damage caused by unauthorized repair work or damage caused by improper use of the products are not covered by the product warranty. No other warranty beyond that specifically set forth above is authorized by GQBrands®.

GLOBAL QUALITY BRANDS® IS NOT RESPONSIBLE OR LIABLE FOR INDIRECT, SPECIAL OR CONSEQUENTIAL DAMAGES ARISING OUT OF OR IN CONNECTION WITH THE USE OR PERFORMANCE OF THE PRODUCT OR OTHER DAMAGES WITH RESPECT TO ANY ECONOMIC LOSS, LOSS OF PROPERTY, LOSS OF REVENUE OR PROFITS, LOSS OF ENJOYMENT OR USE, COST OF REMOVAL, INSTALLATION OR OTHER CONSEQUENTIAL DAMAGES. SOME STATES DO NOT ALLOW THE EXCLUSION OR LIMITATION OF INCIDENTAL OR CONSEQUENTIAL DAMAGES. ACCORDINGLY,

THE ABOVE LIMITATION MAY NOT APPLY TO YOU. THE WARRANTY EXTENDED HEREUNDER IS IN LIEU OF ALL OTHER WARRANTIES AND GLOBAL QUALITY BRANDS®, SPECIFICALLY DISCLAIMS ANY IMPLIED WARRANTY OF MERCHANTABILITY OR FITNESS FOR A PARTICULAR PURPOSE IS LIMITED IN ITS SCOPE AND DURATION TO THE TERMS SET FORTH HEREIN. SOME STATES DO NOT ALLOW LIMITATION ON HOW LONG AN IMPLIED WARRANTY LASTS. ACCORDINGLY, THE ABOVE LIMITATION MAY NO APPLY TO YOU. THIS WARRANTY GIVES YOU SPECIFIC LEGAL RIGHTS. YOU MAY ALSO HAVE OTHER RIGHTS, WHICH VARY FROM STATE TO STATE.

WHILE EVERY ATTEMPT IS MADE TO ENSURE THE HIGHEST DEGREE OF PROTECTION IN ALL EQUIPMENT, WE CANNOT GUARANTEE FREEDOM OF INJURY. THE USER ASSUMES ALL RISK OF INJURY DUE TO USE. ALL MERCHANDISE IS SOLD ON THIS CONDITION, WHICH NO REPRESENTATIVE OF GQBRANDS® CAN WAIVE OR CHANGE.



# WARNINGS



## **ADULT ASSEMBLY REQUIRED** **CHOKING HAZARD - Small Parts** **NOT for children under 3 years of age.**

**Please read these warnings and the information in this manual in its entirety.**

Failure to comply with the following instructions may increase the risk of serious injury and/or death:

- This unit must be assembled and disassembled by ADULTS ONLY.
- This Wavy Slide is suitable for use by most children 3 to 7 years of age.
- Never use this product in any manner other than its intended use.
- DO NOT exceed the maximum weight limit of 100lbs (45.35kgs) regardless of age.
- This unit has a maximum fall weight maximum fall height of 43.5"
- DO NOT install this equipment over concrete, asphalt, or any other hard or rough surface. The Wavy Slide should always be installed over an appropriate, stable surface (rubber mat, grass, etc). It is recommended that whenever possible the ground anchors are used and firmly inserted into the ground.
- Carpeting and thin mats are generally not adequate protective surfacing. Ground level equipment—such as a sandbox, activity wall, playhouse or other equipment that has no elevated play surface—does not need any protective surfacing.
- ALWAYS locate this equipment on a stable, level surface AT LEAST 7 feet away from any structure, obstruction, or possible hazard(s) such as walls, pools, power lines, verhangs, other playground equipment, driveways, hard surfaces and/or roadways.
- Children must be supervised at all times when using this equipment. DO NOT leave children unattended at any time. This Wavy Slide is NOT for adult or adolescent use.
- DO NOT attach items to the Wavy Slide not specifically designed for this purpose. Especially in the case of jump ropes, chains, clotheslines, pet leashes and cables. These may cause a strangulation or physical hazard.
- This Wavy Slide is only designed for family residential use. NOT intended for commercial applications and/or use in public areas such as schools, parks, nurseries, day schools, day cares, etc. DO NOT allow more than one child on the Wavy Slide and Ladder at a time.
- Instruct children to always be sure that the chute opening at the bottom is clear of any persons, pets or obstructions before sliding.
- DO NOT allow children to wear glasses or helmets when using the Wavy Slide.
- At the time of disposal, this item must be completely disassembled and separated into its component types (metals, plastics) for recycling or pick-up according to local ordinances for sanitation pickup.
- DO NOT allow children to wear loose fitting clothing, clothing with straps/loops, backpacks or wear and/or hold accessories with straps or loops, or any article of clothing or accessory with sharp edges which may present a hazard or become snagged or caught on the Wavy Slide during use. Serious injury and/or accidental strangulation may occur.
- DO NOT place objects on or under the slide, or allow people and pets to stand or sit on, near or under the Wavy Slide and Ladder when in use.
- DO NOT allow children to stand on the slide, attempt to walk up the slide or hang from the steel tubing – this can cause serious injury. Children must ALWAYS remain securely seated, in the forward facing position when sliding. Do not lay down, slide from a standing position, or slide down the chute back-wards. DO NOT allow children to stand on the slide top.
- DO NOT use in adverse weather conditions, while the seats are wet, or in poorly lit conditions.
- ALWAYS secure the Wavy Slide against unauthorized and unsupervised use. ALWAYS wear the appropriate footwear (i.e. closed toe shoes) when using the Wavy Slide.
- It is recommended that children wear long pants when using this slide to prevent friction of skin against the chute. At the end of the play season or when the temperature drops below 40 degrees F, this unit must be stored indoors, or disassembled and stored inside.
- Maintain a minimum depth of 9 inches of loose-fill materials such as wood mulch/chips, engineered wood fiber (EWF), or shredded/ recycled rubber mulch for equipment up to 8 feet high; and 9 inches of sand or pea gravel for equipment up to 5 feet high.
- Use a minimum of 6 inches of protective surfacing for play equipment less than 4 feet in height. If maintained properly, this should be adequate. (At depths less than 6 inches, the protective material is too easily displaced or compacted.)
- Use containment, such as digging out around the perimeter and/or lining the perimeter with landscape edging. Don't forget to account for water drainage.
- Check and maintain the depth of the loose-fill surfacing material. To maintain the right amount of loose-fill materials, mark the correct level on play equipment support posts. That way you can easily see when to replenish and/or redistribute the surfacing.
- Please read and refer to other warnings and use information in the Wavy Slide instructions before use.
- Before each use of this product and twice per month, inspect and re-place any worn, loose, defective or missing parts and/or bolts. It is important to check the entire Wavy Slide to ensure the Chute is in good condition. If any loose, cracked, missing, or otherwise damaged components are found, cease use of this item immediately. Check metal parts for rust. If rust is found, sand and repaint using a non-lead based paint. If removed for winter storage, reinstall any plastic parts before allowing use. Rake and check depth of loose fill protective surfacing materials and replace if necessary.
- Owners shall be responsible for maintaining the legibility of the warning labels.

# PARTS LIST

**1 - M6 Nut**

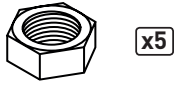

**5 - M6 45mm Bolt**

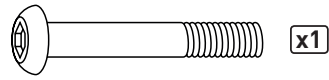

**2a - Washer**



**2 - M6 Dome Nut**

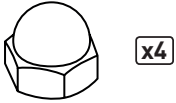

**6 - M6 45mm Bolt**

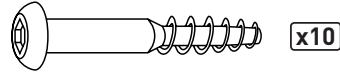

**3 - M6 15mm Bolt**

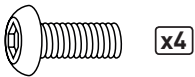

**7 - Ground Anchor**



**9 - Slide Chute**

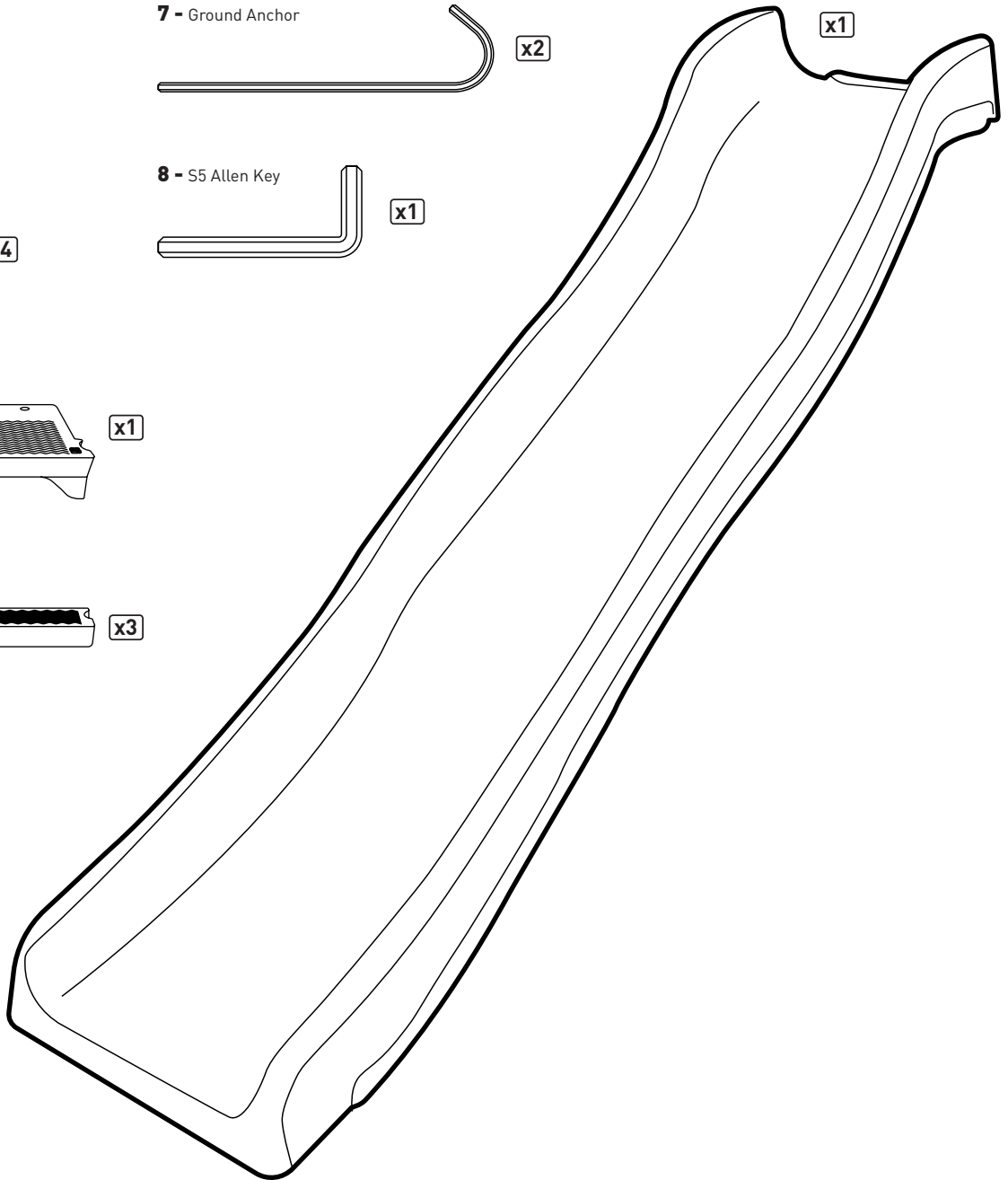

**4 - M6 35mm Bolt**

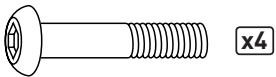

**8 - S5 Allen Key**

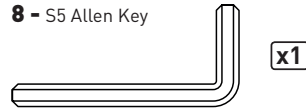

**10 - Ladder Platform**

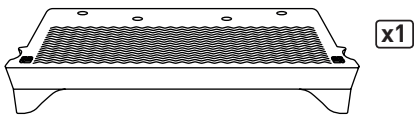

**11 - Platform (ladder step)**

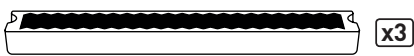

# PARTS LIST

---

12 - Hand Rail Tube (Top)

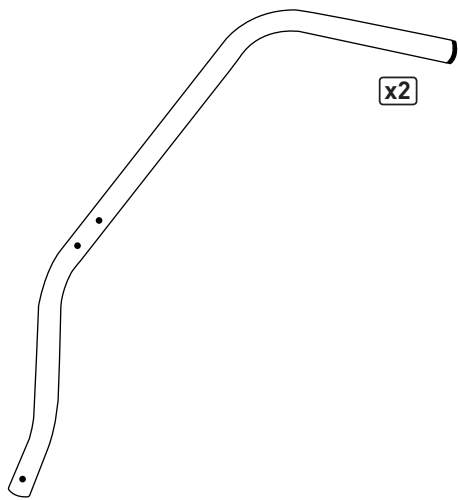

13 - Hand Rail Tube (Bottom)

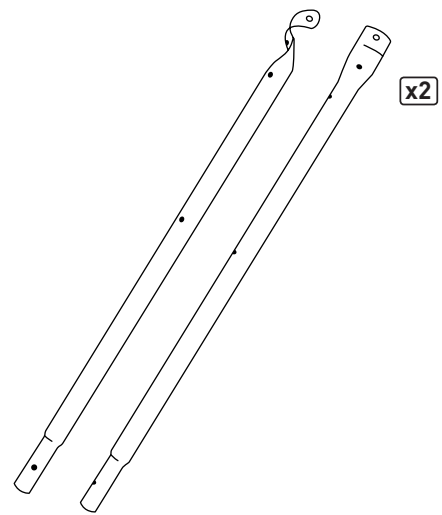

14 - Base Tie Bar (Female)

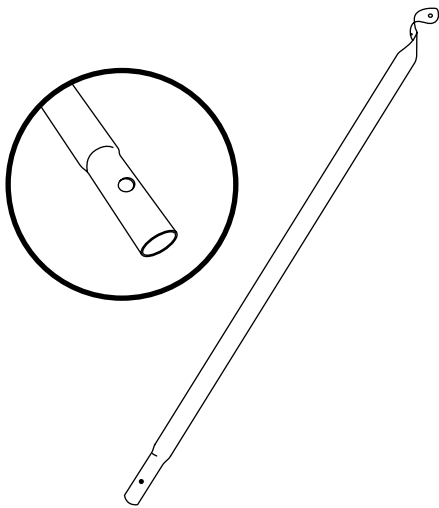

15 - Base Tie Bar (Male)

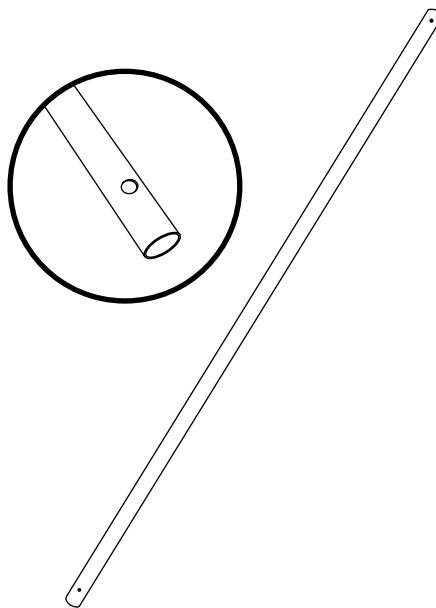

16 - Ladder Stabilizer

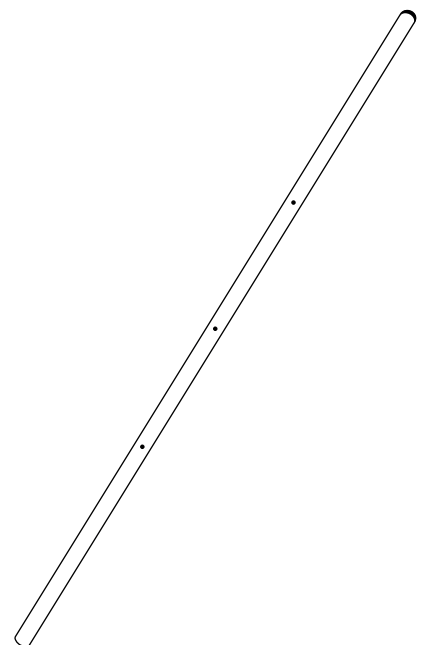

# ASSEMBLY INSTRUCTIONS

## STEP 1

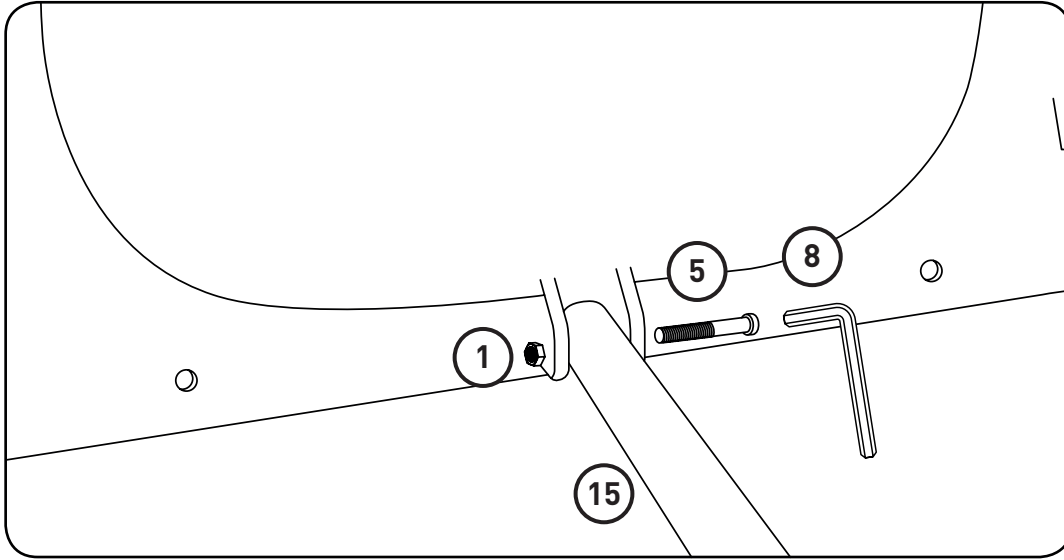

Insert the Male Base Tie Bar (15) at the slide end of Slide Chute (9).

Using M6 45mm Bolt (5) screw it with M6 Nut (1) and tighten them using S5 Allen Key (8).

## STEP 2

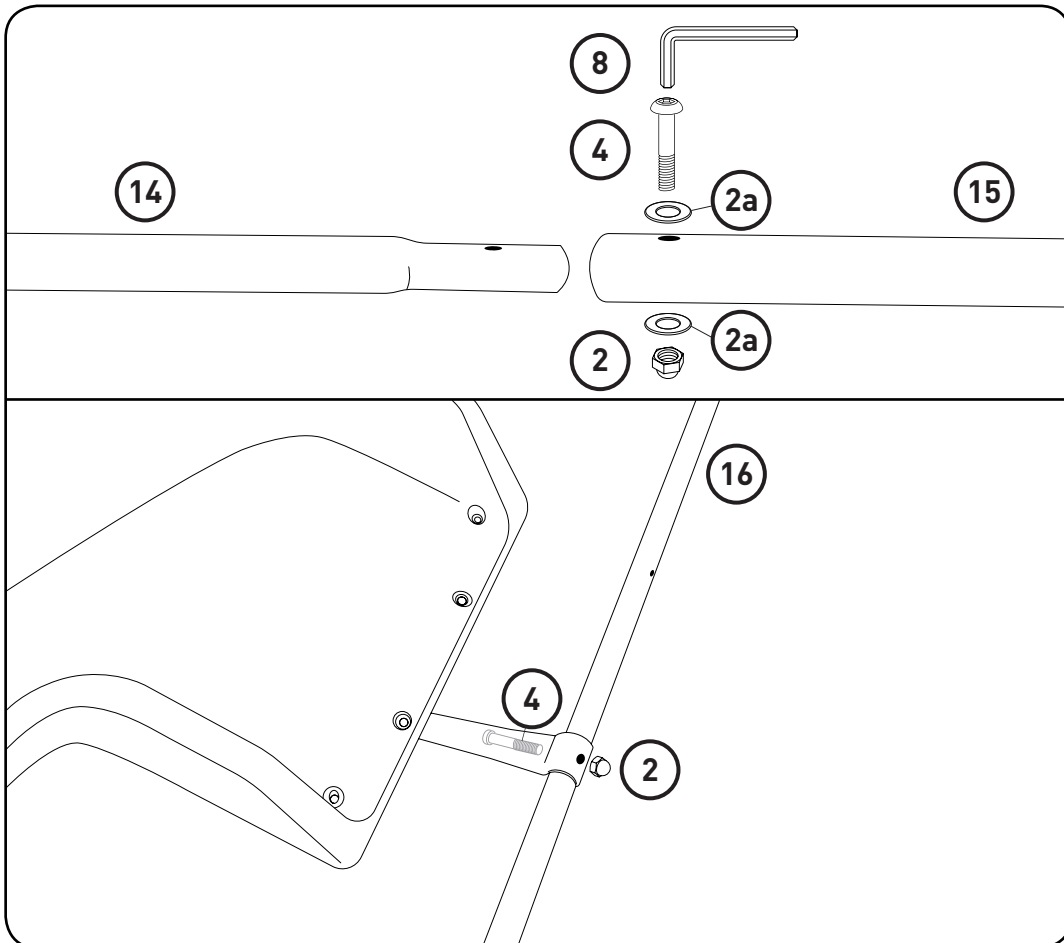

Connect Female Base Tie Bar (14) to Male Base Tie Bar (15), add Washer (2a) on top and bottom and tighten using M6 35mm Bolt (4) with M6 Dome Nut (2).

At the other end of Male Base Tie Bar (15), connect Ladder Stabilizer (16)

# ASSEMBLY INSTRUCTIONS

## STEP 3

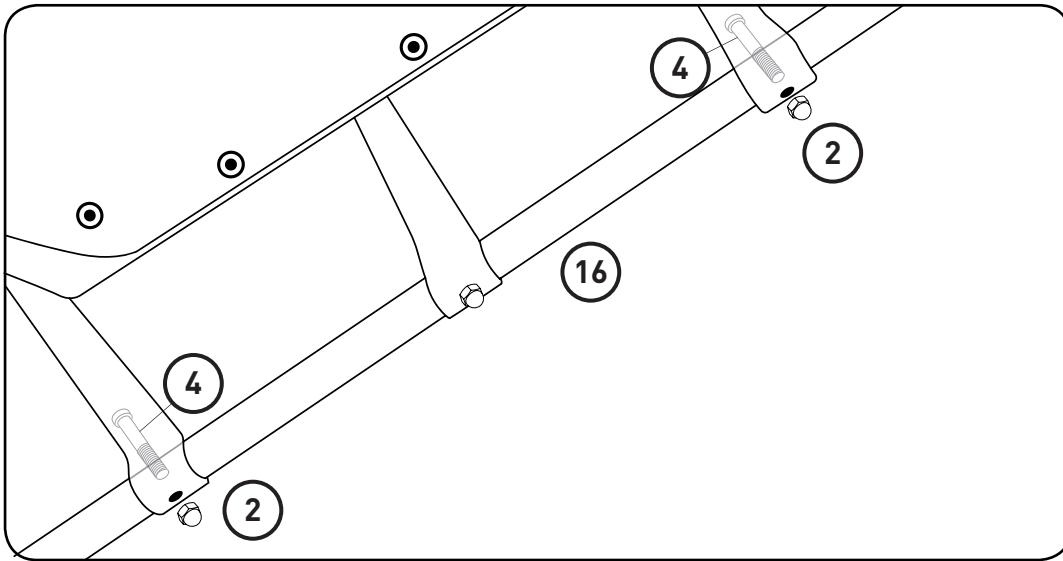

Attach both Hand Rail Tube bottom (13) to Ladder Stabilizer (16), tighten them using M6 Dome Nut (2) and M6 35mm Bolt (4)

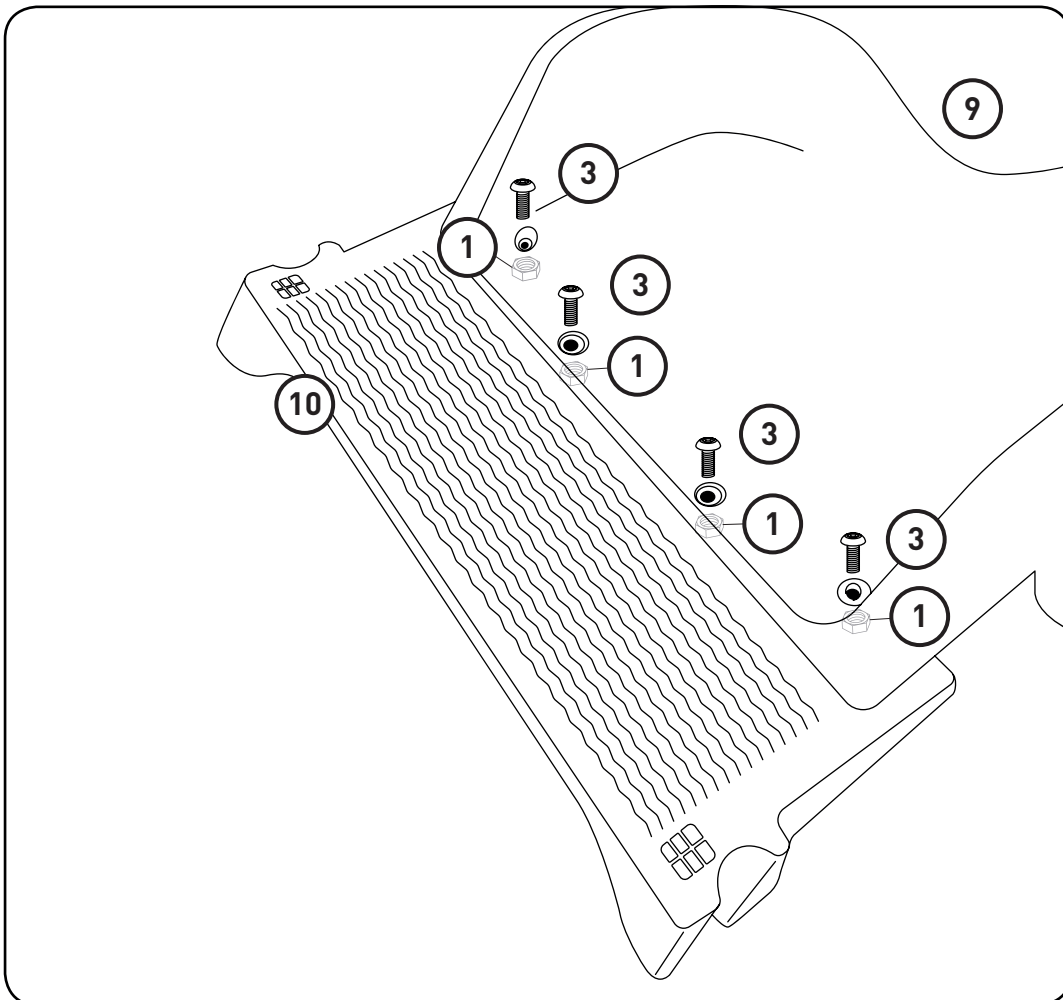

Place the Ladder Platform (10) to the top side of Slide Chut (9), use M6 15mm Bolt (3) with M6 Nut (1) to hold the platform.

# ASSEMBLY INSTRUCTIONS

## STEP 4

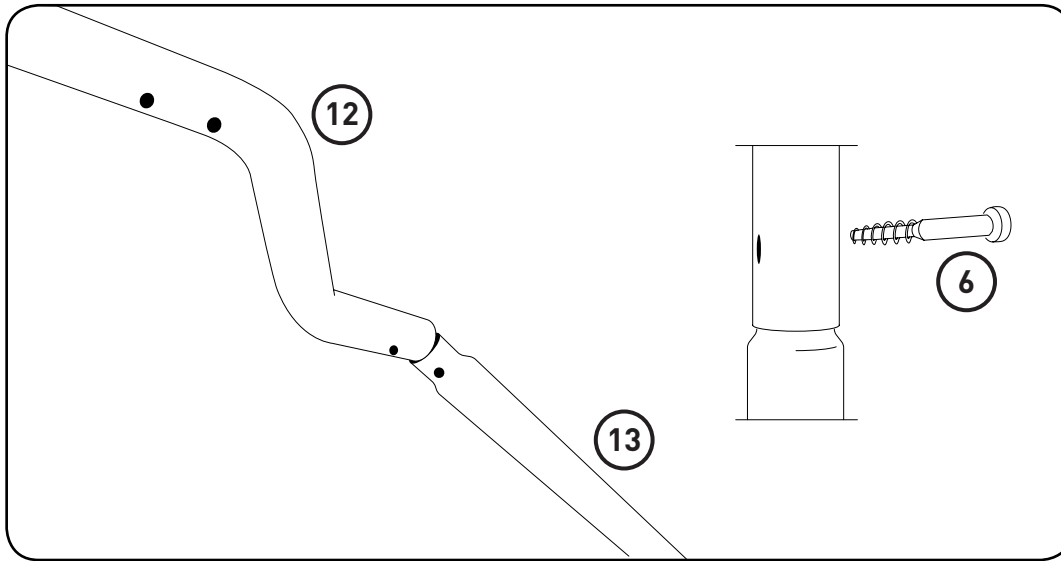

Connect both Top Hand Rail Tube (12) and Hand Rail Tube Bottom (13) and use M6 45mm Bolt (6) to tighten them.

## STEP 5

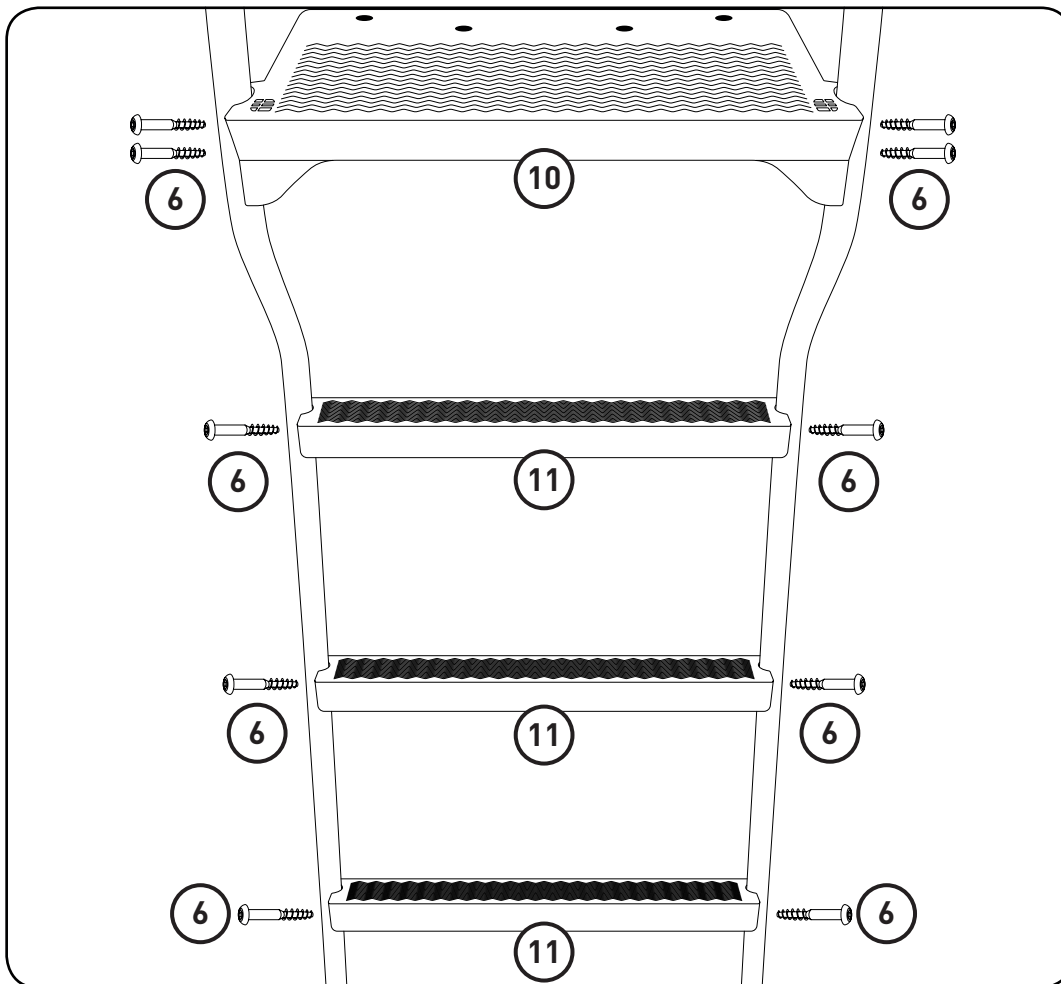

Connect Ladder Platform (10) and 3 Platform (11) to Hand Rail Tubes and use M6 45mm Bolt (6) to tighten them.



# ASSEMBLY INSTRUCTIONS

## STEP 6

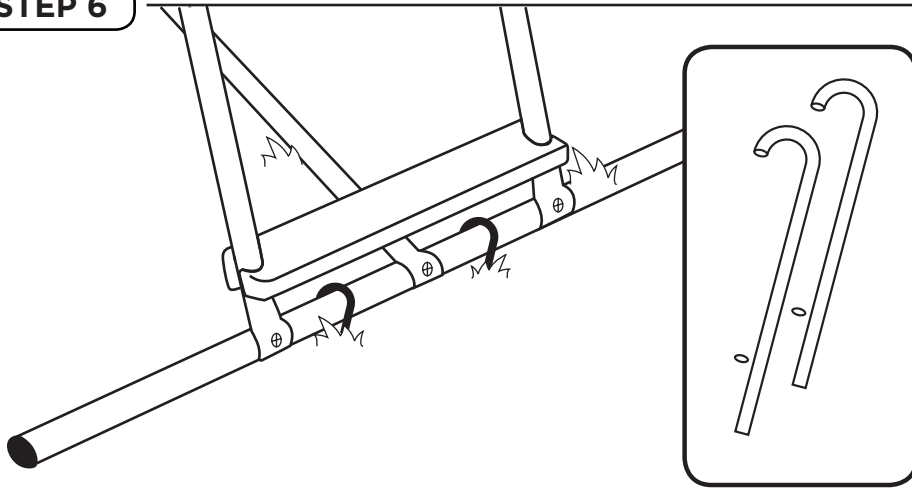

If the Wavy Slide is placed outdoors, use the Ground Anchors to secure it to soft ground to prevent sliding or turning.

