



36-INCH KIDS TRAMPOLINE WITH HANDRAIL

MODEL# 9006KM
PRODUCT MANUAL - VERSION 2.19.1

FOR AGES:

3-7

WEIGHT LIMIT:

75 Lbs

TO BUILD:



TO BUILD:



HOW-TO
VIDEOS ONLINE



Manual en español ubicado en GQBrands.com

Spanish Manual located at GQBrands.com

CUSTOMER SERVICE

GQBrands.com • CustomerService@GQBrands.com • 1-866-498-5269 • 4401 Samuell Blvd, Ste 150, Mesquite, TX 75149



CUSTOMER SERVICE INFORMATION

Thank you for purchasing: 36-INCH KIDS TRAMPOLINE WITH HANDRAIL

MODEL# 9006KM

If you have an issue with your item, do not return. Please report items that are damaged or missing parts to the manufacturer GQ Brands within three days of delivery. Contact customer service at customerservice@gqbrands.com or toll-free at 1-866-498-5269

At GQBrands®, we want all of our customers to be completely satisfied with their purchase. Take time to review the contents of the product you have just received to make sure that all of the parts are included. If you find that any parts are missing or damaged, we will provide replacement parts at no charge within 30 days of purchase.

Please keep in mind that for select damaged part replacement requests, we will require a photo for submission.

To order these parts, or if you have any other questions or concerns about this GQBrands product, please contact us at

PureFun.Net
GQBrands@
Phone: 1-866-498-5269
Email: CustomerService@GQBrands.com
4401 Samuell Blvd, Ste 150,
Mesquite, TX 75149

Please be sure to include the following information when you contact Customer Service:

YOUR NAME: _____

YOUR MAILING ADDRESS: _____

YOUR EMAIL ADDRESS: _____

PRODUCT NAME: _____

PRODUCT MODEL#: _____

PART NUMBER _____

RETAILER WHERE PURCHASED: _____

DATE OF PURCHASE: _____

ORDER NUMBER: *(If Available)* _____

SERIAL NUMBER: *(If Available)* _____

QUANTITY NEEDED: _____

PICTURE OF DAMAGED PART

LIMITED WARRANTY

Global Quality Brands® warrants this product to be free from defects in workmanship and materials under normal use and conditions for a period of 90 DAYS FROM THE DATE OF ORIGINAL PURCHASE. This Limited Warranty is not transferable and is available only for the original purchaser of the Product. The Company's obligation under this warranty is limited to replacing or repairing the Product, at the discretion of the company.

All warranty coverage extends only to the original retail purchaser from the date of purchase, GQ Brands obligation under this warranty is limited to replacing or repairing, at Global Quality Brands® option. All products for which a warranty claim is made must be received by Global Quality Brands® and accompanied by sufficient proof of purchase (photocopy of the original store receipt, indicating the date of purchase). All freight and handling fees are the responsibility of the consumer to pay, both to and from Global Quality Brands®. All warranty claims must be preauthorized by Global Quality Brands® pre-authorization can be obtained by calling 866-498-5269.

This warranty does not cover ordinary wear and tear, weathering, failure to follow directions, improper installation, improper maintenance, or acts of nature, (such as damage caused by wind, lightning, snow, water, or ice) weather damage, damage caused by unauthorized repair work or damage caused by improper use of the products are not covered by the product warranty. No other warranty beyond that specifically set forth above is authorized by GQBrands®.

GLOBAL QUALITY BRANDS® IS NOT RESPONSIBLE OR LIABLE FOR INDIRECT, SPECIAL OR CONSEQUENTIAL DAMAGES ARISING OUT OF OR IN CONNECTION WITH THE USE OR PERFORMANCE OF THE PRODUCT OR OTHER DAMAGES WITH RESPECT TO ANY ECONOMIC LOSS, LOSS OF PROPERTY, LOSS OF REVENUE OR PROFITS, LOSS OF ENJOYMENT OR USE, COST OF REMOVAL, INSTALLATION OR OTHER CONSEQUENTIAL DAMAGES. SOME STATES DO NOT ALLOW THE EXCLUSION OR LIMITATION OF INCIDENTAL OR CONSEQUENTIAL DAMAGES. ACCORDINGLY,

THE ABOVE LIMITATION MAY NOT APPLY TO YOU. THE WARRANTY EXTENDED HEREUNDER IS IN LIEU OF ALL OTHER WARRANTIES AND GLOBAL QUALITY BRANDS®, SPECIFICALLY DISCLAIMS ANY IMPLIED WARRANTY OF MERCHANTABILITY OR FITNESS FOR A PARTICULAR PURPOSE IS LIMITED IN ITS SCOPE AND DURATION TO THE TERMS SET FORTH HEREIN. SOME STATES DO NOT ALLOW LIMITATION ON HOW LONG AN IMPLIED WARRANTY LASTS. ACCORDINGLY, THE ABOVE LIMITATION MAY NO APPLY TO YOU. THIS WARRANTY GIVES YOU SPECIFIC LEGAL RIGHTS. YOU MAY ALSO HAVE OTHER RIGHTS, WHICH VARY FROM STATE TO STATE.

WHILE EVERY ATTEMPT IS MADE TO ENSURE THE HIGHEST DEGREE OF PROTECTION IN ALL EQUIPMENT, WE CANNOT GUARANTEE FREEDOM OF INJURY. THE USER ASSUMES ALL RISK OF INJURY DUE TO USE. ALL MERCHANDISE IS SOLD ON THIS CONDITION, WHICH NO REPRESENTATIVE OF GQBRANDS® CAN WAIVE OR CHANGE.



WARNINGS



ADULT ASSEMBLY REQUIRED **CHOKING HAZARD - Small Parts** **NOT for children under 3 years of age.**

Please read these warnings and the information in this manual in its entirety.

Failure to comply with the following instructions may increase the risk of serious injury and/or death:

- This unit must be assembled and disassembled by **ADULTS ONLY**.
- Children must be supervised at all times when using this equipment. **DO NOT** leave children unattended at any time.
- Children **MUST NEVER** use the trampoline unless supervised by a responsible adult with knowledge of trampoline use.
- This trampoline is **SUITABLE** for use by most children **3 TO 7 YEARS OF AGE**.
- **DO NOT** exceed the **MAXIMUM WEIGHT** limit of 75lbs (35kgs) regardless of age.
- This trampoline is **NOT** for adult use.
- This trampoline is only designed for normal residential indoor use. It is **NOT** intended for commercial applications and/or in public areas such as schools, parks, nurseries, day schools, day cares, etc.
- For **INDOOR USE ONLY**: Your trampoline should be placed at a safe distance from any obstructions, stairways, windows, furniture, appliances, etc.
- **DO NOT** allow more than one person on the trampoline at a time.
- **DO NOT** wear glasses or helmets when using the trampoline.
- **DO NOT** fall or bounce on your knees — this can cause serious injury.
- **DO NOT** somersault - this can cause serious injury resulting in paralysis or death.
- **DO NOT** allow other persons to go under, sit, stand or lie on or near the frame pads or mat while the trampoline is in use.
- Mount and dismount the trampoline with care as injury may result.
- **DO NOT** use or allow use of the trampoline under the influence of any substance or medication which may impair the supervisor's or jumper's judgment and/or coordination.
- **ALWAYS** remove jewelry, belt buckles, or any other sharp objects before using the trampoline.
- **ALWAYS** jump in the middle of the trampoline bed.
- **ALWAYS** secure the trampoline against unauthorized and unsupervised use.
- **ALWAYS** wear socks when using the trampoline.
- **NEVER** wear footwear (e.g. shoes) when using the trampoline.
- Before using this product, inspect and replace any worn, defective or missing parts. Although the cord, pad, foam and mat are made to take a lot of wear, over time these parts may need to be replaced. It is important to check the trampoline periodically to ensure the frame is steady and all parts are in good condition.
- If any part of the trampoline requires cleaning, simply wipe with a damp cloth. (Do not jump on the trampoline after cleaning until completely dry)
- If the paint is chipped, we recommend you lightly rub the damaged area and cover using a non-toxic enamel paint.
- **IMPORTANT**: While no regular maintenance is required, you must inspect the trampoline before each use and replace any worn, defective, or missing parts. **ALWAYS** supervise your children while they are playing on or around the trampoline.
- The unit is **NEVER** to be used by more than one child at a time.
- The trampoline is designed so the child can bounce and balance on the mat. Successfully meeting this challenge builds children's confidence as well as helping muscular development and coordination. Confidence depends on success - so it is important to allow your children to learn at their own pace, giving them a helping hand when necessary.
- **NEVER** allow your child to attempt somersaults or flips on this trampoline as it is not designed for such play features.
- The trampoline should **NOT** be used in conjunction with, or attached to any other play equipment.
- The trampoline handle is only intended to assist your child with controlling their bounce and maintaining their balance on the mat. **NEVER** use the handle for any other purpose or as climbing feature.
- This trampoline is **NOT** intended to be used by adults.
- Children are **NOT** to stand or sit on the edge of the trampoline.
- Children are **NOT** to perform knee or drop bounces on the trampoline.
- The following conditions could represent potential hazards: Missing, improperly positioned, or insecurely attached frame padding; punctures, frays, tears, or holes worn in the bed or frame padding; deterioration in the stitching or fabric of the bed or frame padding; frayed or damaged bungee cord; a bent or broken frame; a sagging jump mat, or sharp protrusions on the frame or suspension system. Cease using trampoline immediately and secure it against unauthorized use if any of these conditions are present.

PARTS LIST

1 - Top Rail Frame

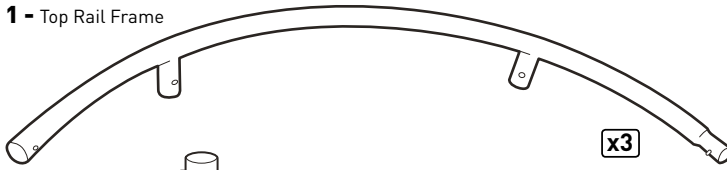

2 - Leg

x6

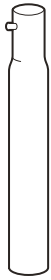

x3

2A - Leg Cap

x6



5 - Center Handlebar

x1



3 - Left Handle Base

x1

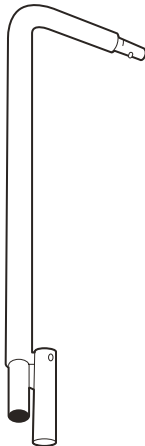

4 - Right Handle Base

x1

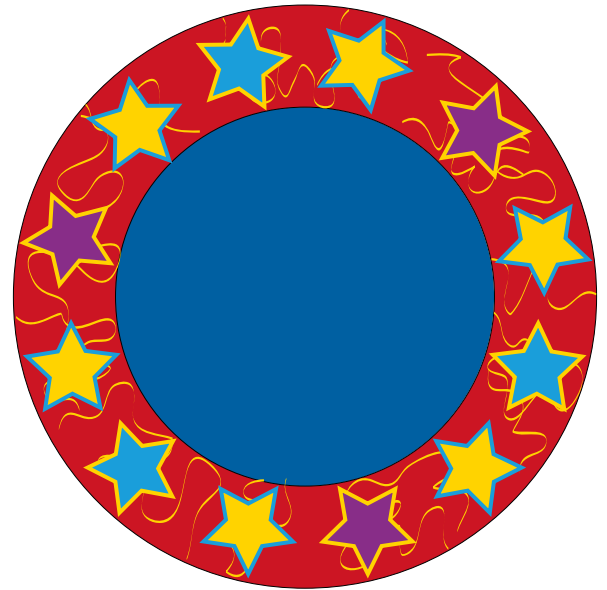

6 - Frame Pad

x1

3 - Left Handle Base

x1

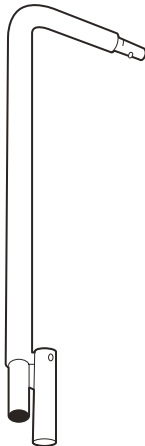

4 - Right Handle Base

x1



pure
fun

7 - Jump Mat

x1



9A - Bungee Cord with Carabiner

x1

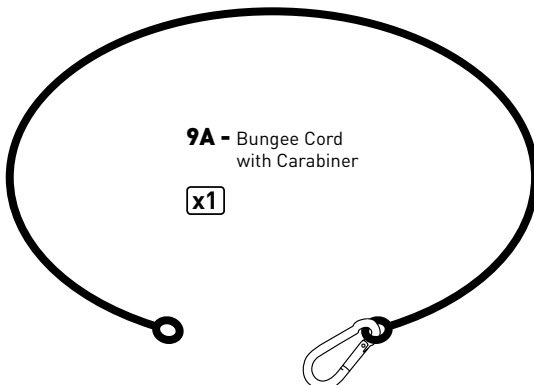

ASSEMBLY INSTRUCTIONS

STEP 1

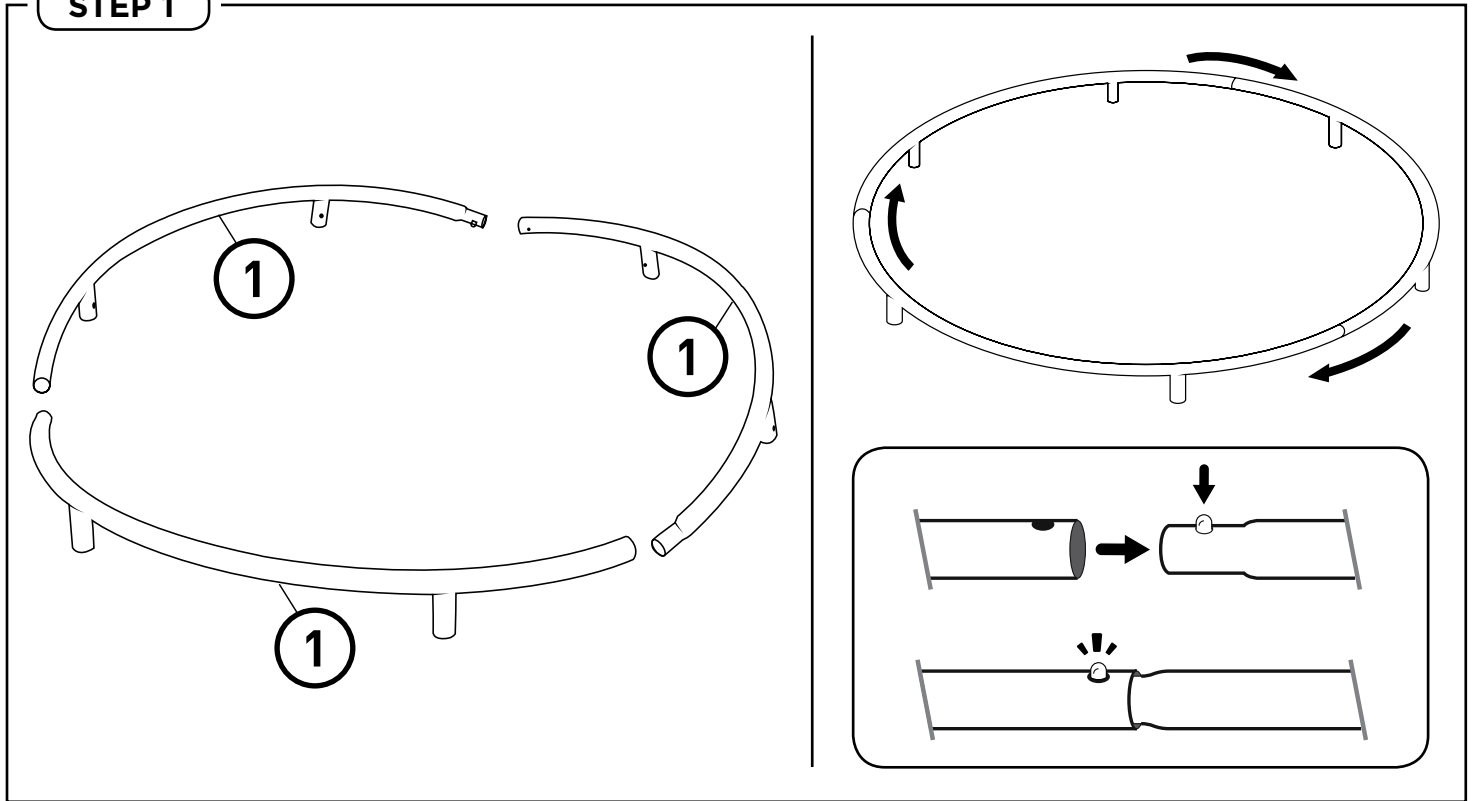

STEP 2

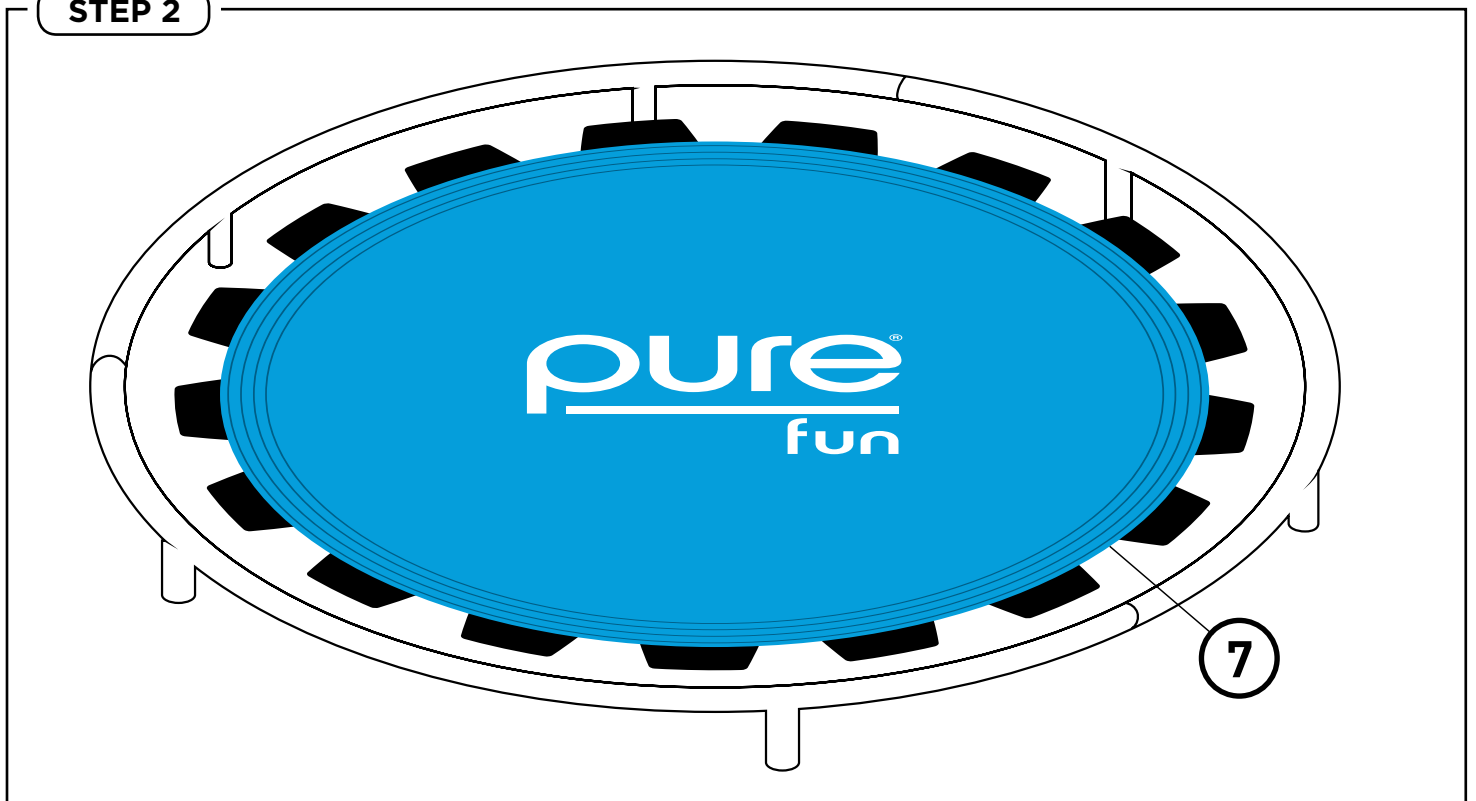

ASSEMBLY INSTRUCTIONS

STEP 3

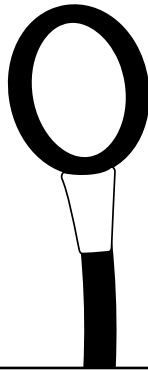
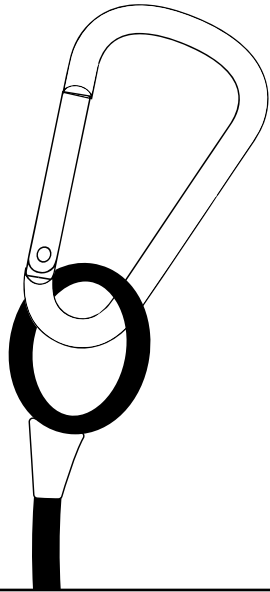

Smaller opening
to loop around
trampoline mat

STEP 4

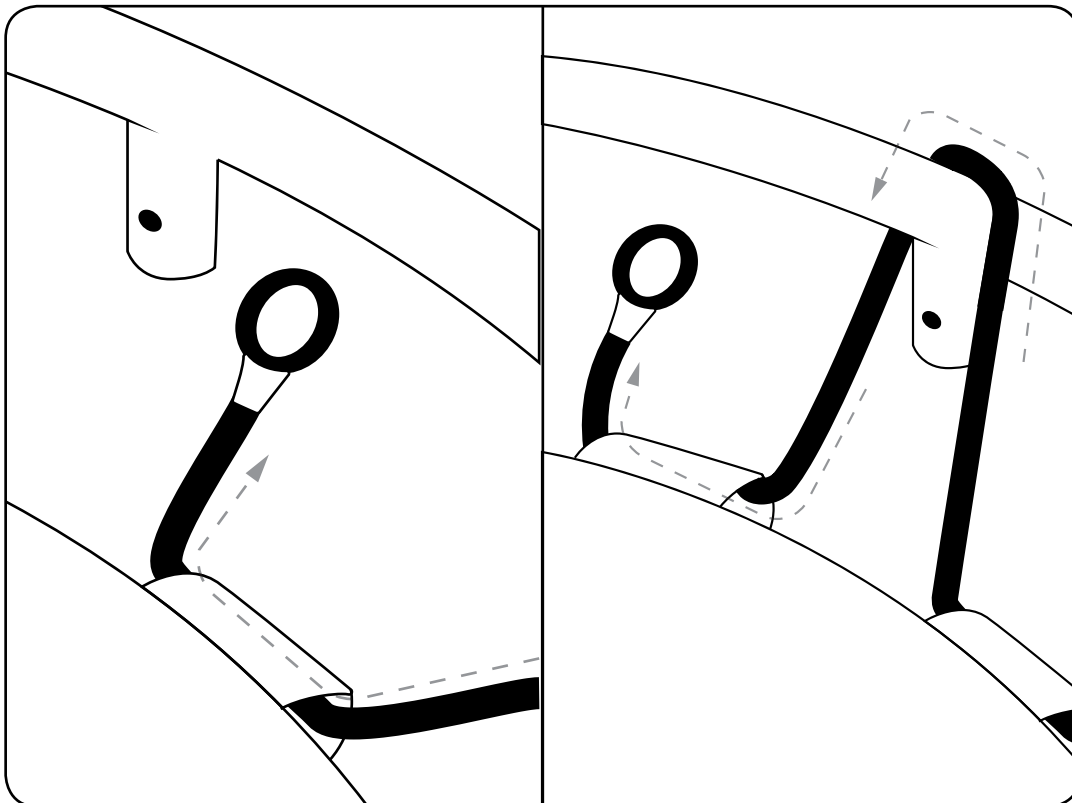

Loop the smaller end
of the cord through
the loops on the jump
mat and then the
trampoline frame.

Keep the spacing
consistent so the jump
mat stays centered
inside of the frame
until the end of the
cord is reached and
hook the carabiner into
the loop at small end
of bungee cord.

ASSEMBLY INSTRUCTIONS

STEP 5

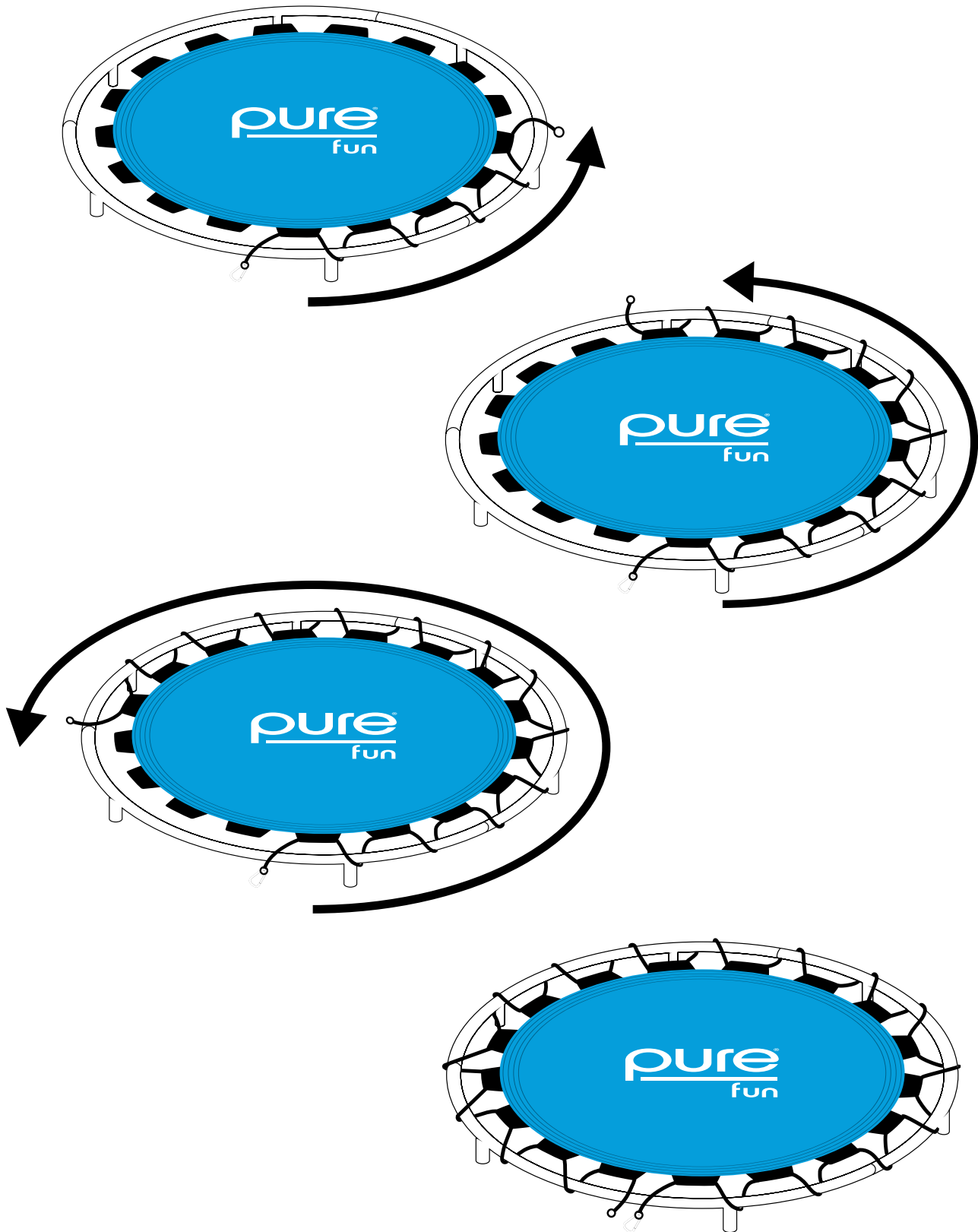

ASSEMBLY INSTRUCTIONS

STEP 6

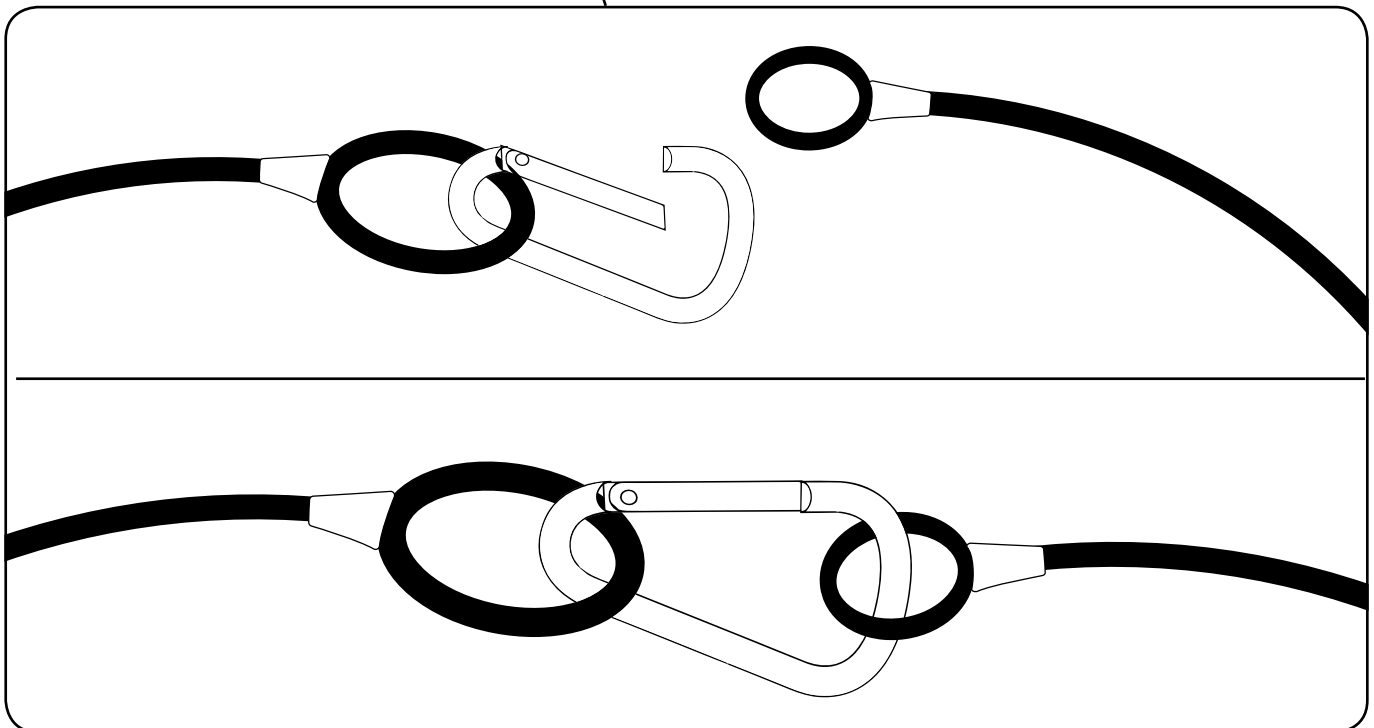
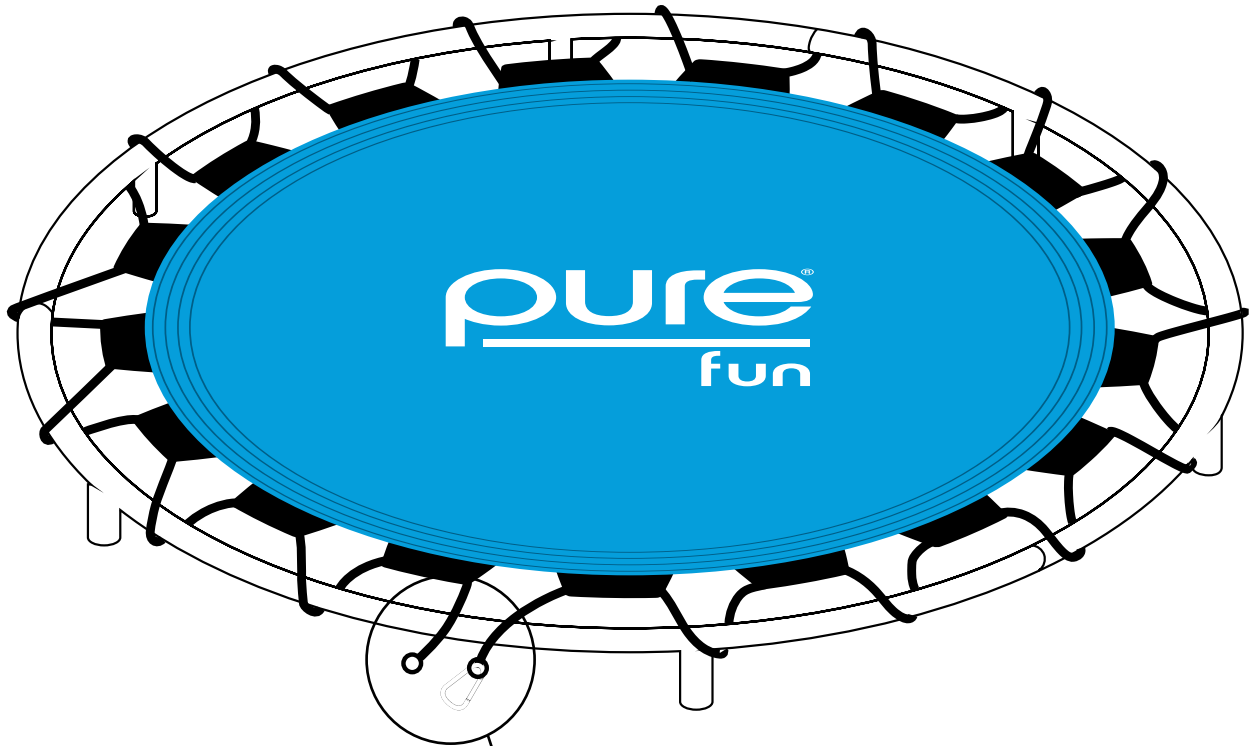

ASSEMBLY INSTRUCTIONS

STEP 7

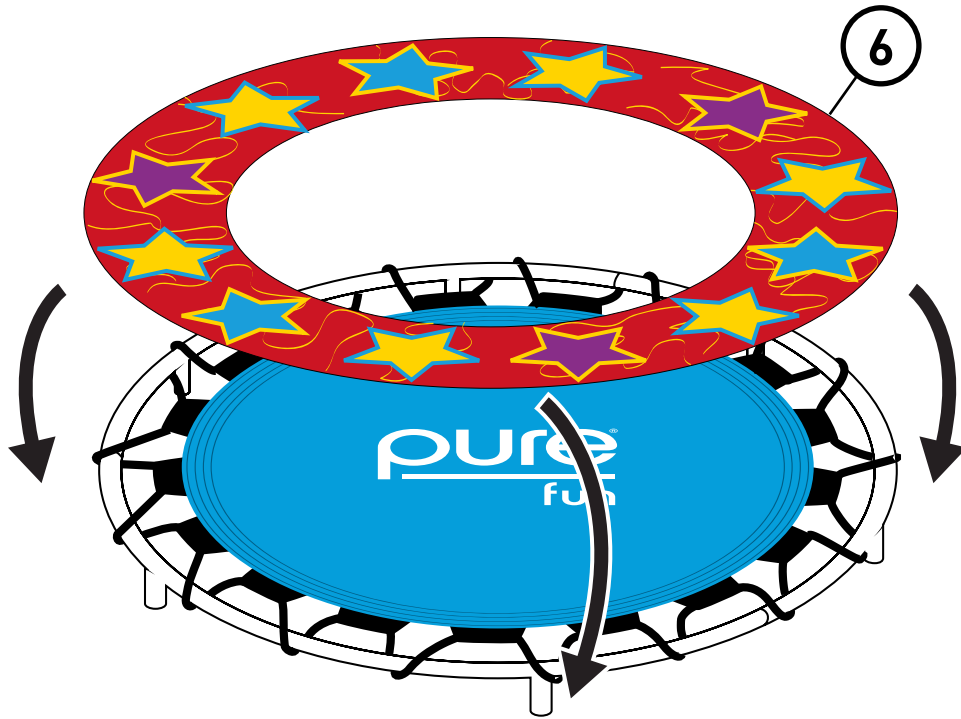

STEP 8

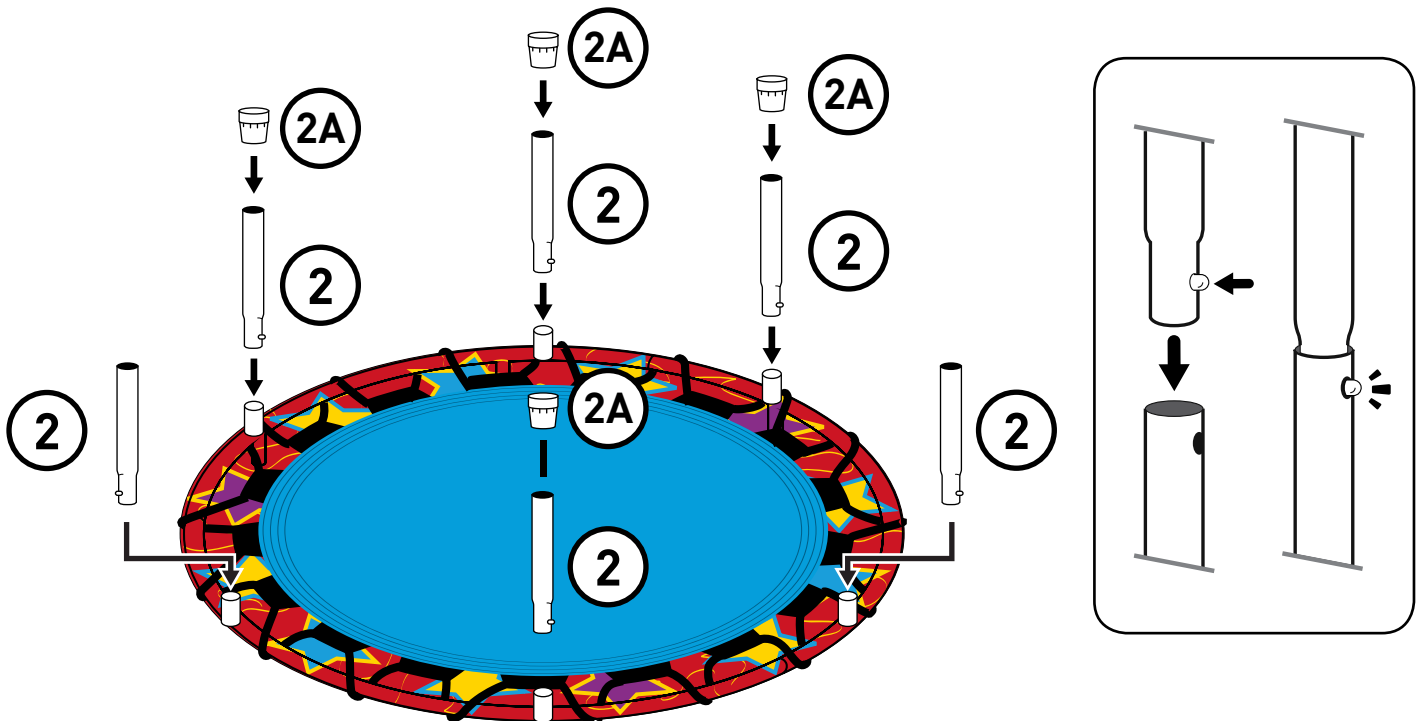

ASSEMBLY INSTRUCTIONS

STEP 9

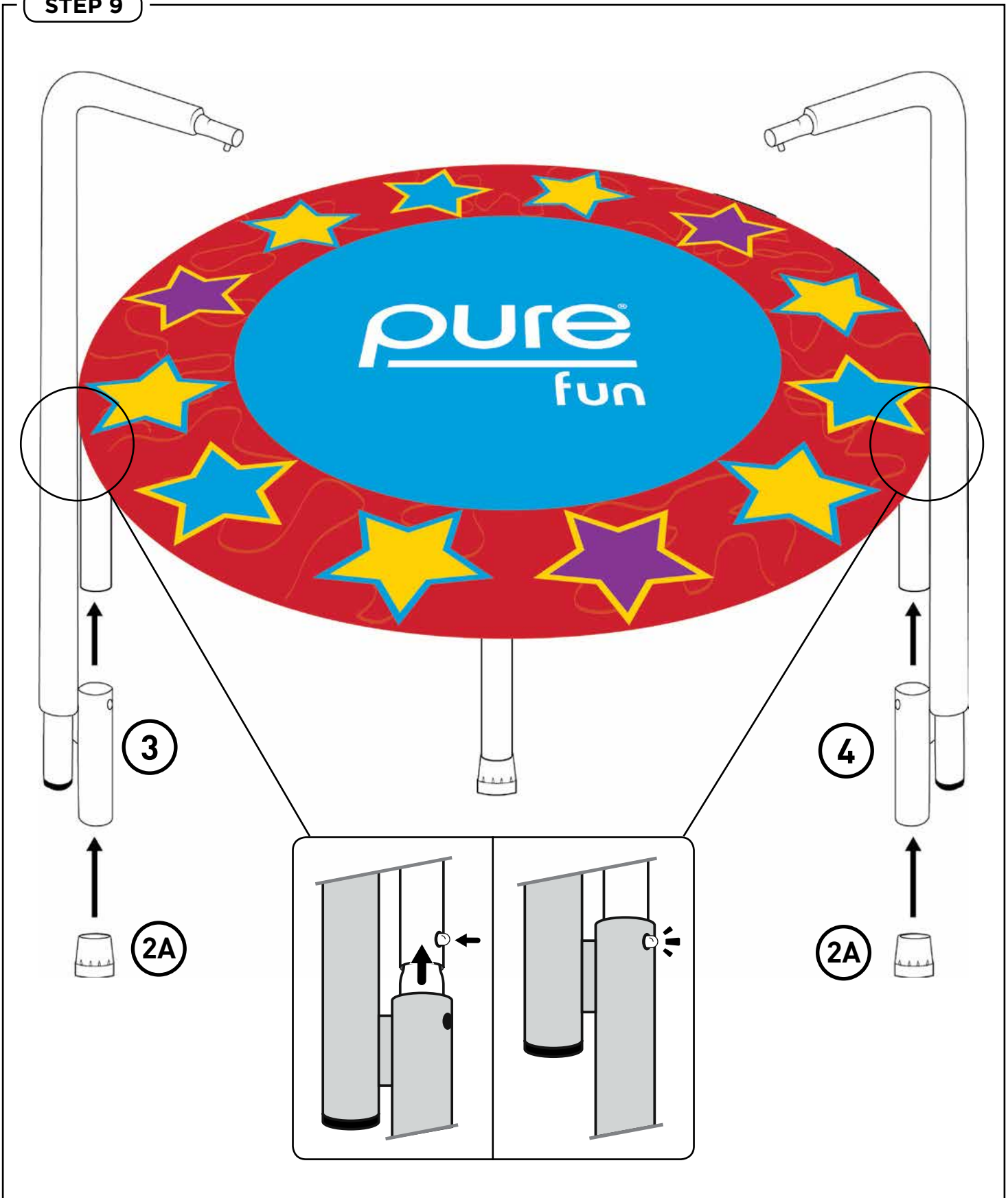

ASSEMBLY INSTRUCTIONS

