



360 QUAD SWIVEL KIDS SEESAW

MODEL# 9334KS
PRODUCT MANUAL - VERSION 12.18.03

FOR AGES:

3-10

WEIGHT LIMIT:

400 Lbs
100 Lbs per seat

TO BUILD:

 **x 1**

TOOLS NEEDED:

N/A



HOW-TO
VIDEOS ONLINE



CUSTOMER SERVICE

GQBrands.com • CustomerService@GQBrands.com • 1-866-498-5269 • 4401 Samuell Blvd, Ste 150, Mesquite, TX 75149



PATENT PENDING *

CUSTOMER SERVICE INFORMATION

Thank you for purchasing: **360 QUAD SWIVEL KIDS SEESAW**

MODEL# 9334KS

At GQBrands®, we want all of our customers to be completely satisfied with their purchase. Take time to review the contents of the product you have just received to make sure that all of the parts are included. If you find that any parts are missing or damaged, we will provide replacement parts at no charge within 30 days of purchase.

Please keep in mind that for select damaged part replacement requests, we will require a photo for submission.

To order these parts, or if you have any other questions or concerns about this GQBrands product, please contact us at

PureFun.Net
GQBrands®
Phone: 1-866-498-5269
Email: CustomerService@GQBrands.com
4401 Samuell Blvd, Ste 150,
Mesquite, TX 75149

Please be sure to include the following information when you contact Customer Service:

YOUR NAME: _____

YOUR MAILING ADDRESS: _____

YOUR EMAIL ADDRESS: _____

PRODUCT NAME: _____

PRODUCT MODEL#: _____

PART NUMBER _____

RETAILER WHERE PURCHASED: _____

DATE OF PURCHASE: _____ **ORDER**

NUMBER: (If Available) _____ **SERIAL**

NUMBER: (If Available) _____

QUANTITY NEEDED: _____

PICTURE OF DAMAGED PART

LIMITED WARRANTY

Global Quality Brands® warrants this product to be free from defects in workmanship and materials under normal use and conditions for a period of 90 DAYS FROM THE DATE OF ORIGINAL PURCHASE. This Limited Warranty is not transferable and is available only for the original purchaser of the Product. The Company's obligation under this warranty is limited to replacing or repairing the Product, at the discretion of the company.

All warranty coverage extends only to the original retail purchaser from the date of purchase. GQ Brands obligation under this warranty is limited to replacing or repairing, at Global Quality Brands® option. All products for which a warranty claim is made must be received by Global Quality Brands® and accompanied by sufficient proof of purchase (photocopy of the original store receipt, indicating the date of purchase). All freight and handling fees are the responsibility of the consumer to pay, both to and from Global Quality Brands®. All warranty claims must be preauthorized by Global Quality Brands® pre-authorization can be obtained by calling 866-498-5269.

This warranty does not cover ordinary wear and tear, weathering, failure to follow directions, improper installation, improper maintenance, or acts of nature, (such as damage caused by wind, lightning, snow, water, or ice) weather damage, damage caused by unauthorized repair work or damage caused by improper use of the products are not covered by the product warranty. No other warranty beyond that specifically set forth above is authorized by GQBrands®.

GLOBAL QUALITY BRANDS® IS NOT RESPONSIBLE OR LIABLE FOR INDIRECT, SPECIAL OR CONSEQUENTIAL DAMAGES ARISING OUT OF OR IN CONNECTION WITH THE USE OR PERFORMANCE OF THE PRODUCT OR OTHER DAMAGES WITH RESPECT TO ANY ECONOMIC LOSS, LOSS OF PROPERTY, LOSS OF REVENUE OR PROFITS, LOSS OF ENJOYMENT OR USE, COST OF REMOVAL, INSTALLATION OR OTHER CONSEQUENTIAL DAMAGES. SOME STATES DO NOT ALLOW THE EXCLUSION OR LIMITATION OF INCIDENTAL OR CONSEQUENTIAL DAMAGES. ACCORDINGLY,

THE ABOVE LIMITATION MAY NOT APPLY TO YOU. THE WARRANTY EXTENDED HEREUNDER IS IN LIEU OF ALL OTHER WARRANTIES AND GLOBAL QUALITY BRANDS®, SPECIFICALLY DISCLAIMS ANY IMPLIED WARRANTY OF MERCHANTABILITY OR FITNESS FOR A PARTICULAR PURPOSE IS LIMITED IN ITS SCOPE AND DURATION TO THE TERMS SET FORTH HEREIN. SOME STATES DO NOT ALLOW LIMITATION ON HOW LONG AN IMPLIED WARRANTY LASTS. ACCORDINGLY, THE ABOVE LIMITATION MAY NO APPLY TO YOU. THIS WARRANTY GIVES YOU SPECIFIC LEGAL RIGHTS. YOU MAY ALSO HAVE OTHER RIGHTS, WHICH VARY FROM STATE TO STATE.

WHILE EVERY ATTEMPT IS MADE TO ENSURE THE HIGHEST DEGREE OF PROTECTION IN ALL EQUIPMENT, WE CANNOT GUARANTEE FREEDOM OF INJURY. THE USER ASSUMES ALL RISK OF INJURY DUE TO USE. ALL MERCHANDISE IS SOLD ON THIS CONDITION, WHICH NO REPRESENTATIVE OF GQBRANDS® CAN WAIVE OR CHANGE.

WARNINGS



ADULT ASSEMBLY REQUIRED **CHOKING HAZARD - Small Parts** **NOT** for children under 3 years of age.

Please read these warnings and the information in this manual in its entirety.

Failure to comply with the following instructions may increase the risk of serious injury and/or death:

- This unit must be assembled and disassembled by ADULTS ONLY.
- This See Saw is suitable for use by most children 3 to 10 YEARS OF AGE.
- Never use this product in any manner other than its intended use.
- DO NOT exceed the MAXIMUM WEIGHT limit of 400lbs (100 Lbs per seat) regardless of age.
- This unit has a MAXIMUM FALL HEIGHT of 43.5"
- DO NOT install this equipment over concrete, asphalt, or any other hard or rough surface. The See Saw should always be installed over an appropriate, stable surface (rubber mat, grass, etc).
- ALWAYS locate this equipment on a stable, level surface AT LEAST 7 feet away from any structure, obstruction, or possible hazard(s) such as walls, pools, power lines, overhangs, other playground equipment, driveways, hard surfaces and/or roadways.
- Children must be supervised at all times when using this equipment. DO NOT leave children unattended at any time.
- DO NOT attach items not specifically designed for this purpose. Especially in the case of jump ropes, chains, clotheslines, pet leashes and cables. These may cause a strangulation or physical hazard.
- This See Saw is NOT for adult or adolescent use.
- DO NOT allow children to stand on the seesaw.
- This See Saw is only designed for family residential use. It is NOT intended for commercial applications and/or use in public areas such as schools, parks, nurseries, day schools, day cares, etc.
- DO NOT allow more than one child on each See Saw seat at a time.
- Instruct children to always be sure that the area under and around the seesaw is clear of any persons, pets or obstructions before using.
- DO NOT allow children to wear glasses or helmets when using the See Saw, including bike or other sports helmets.
- DO NOT allow children to wear loose fitting clothing, clothing with straps/loops, backpacks or wear and/or hold accessories with straps or loops, or any article of clothing or accessory with sharp edges which may present a hazard or become snagged or caught on the See Saw during use. Serious injury and/or accidental strangulation may occur.
- DO NOT place objects on or under the see saw, or allow people and pets to stand or sit on, near or under the See Saw when in use.
- DO NOT allow children to stand on the frame, or hang from the steel tubing – this can cause serious injury.
- Children must ALWAYS remain securely seated, in the forward facing position when using.
- DO NOT use in adverse weather conditions, while the seats are wet, or in poorly lit conditions.
- ALWAYS secure the See Saw against unsupervised use.
- ALWAYS wear the appropriate footwear (i.e. closed toe shoes) when using the See Saw.
- Before each use of this product and twice per month, inspect and replace any worn, loose, defective or missing parts and tighten all hardware. All moving parts should be lubricated with a household lubricant.
- It is important to check the entire See Saw to ensure the Frame Tubing, Protective Coverings, and Seats are steady and all parts and tubing caps are attached in good condition. If any loose, cracked, missing, or otherwise damaged components are found, cease use of this item immediately.
- Check metal parts for rust. If rust is found, sand and repaint using a non-lead based paint. If removed for winter storage, reinstall any plastic parts before allowing use.
- Rake and check depth of loose fill protective surfacing materials to prevent compaction and maintain appropriate depth. Replace as necessary.
- At the end of the play season or when the temperature drops below 40 degrees Fahrenheit, this unit must be disassembled and stored inside.
- Owners shall be responsible for maintaining the legibility of the warning labels.
- Please read and refer to other warnings and use information in the See Saw instructions before use.
- Dispose of all packaging materials safely and per local ordinance.
- Patent Pending

PARTS LIST

1- Main Center Pole

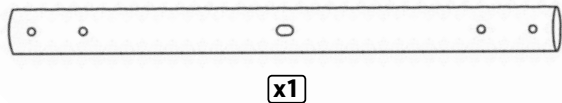

2- Main Side Bar

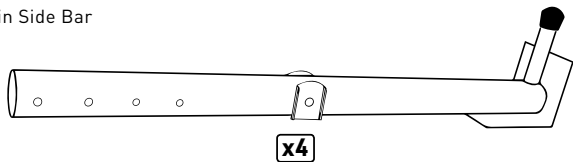

3- Curved Main Bar

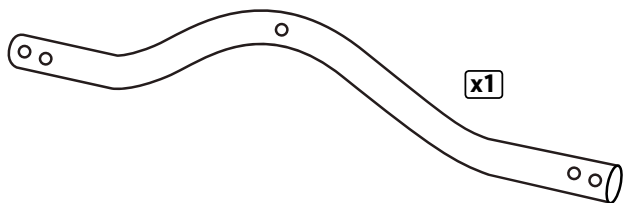

4- Leg with Upper Openings

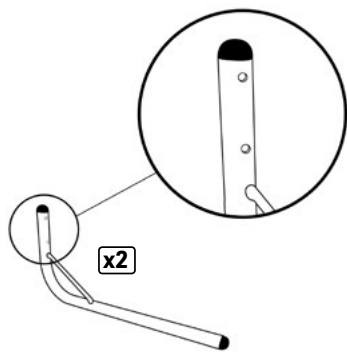

5- Leg with Lower Openings

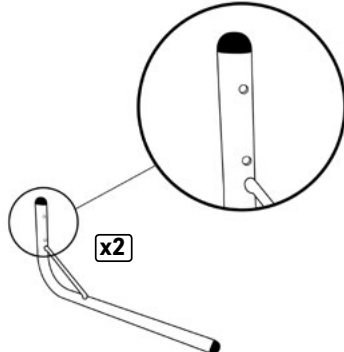

6- Handle Bar with Foam

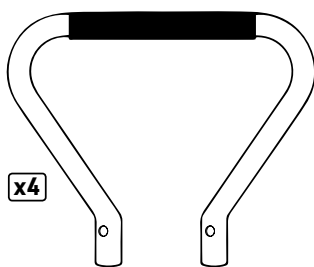

7- Seat

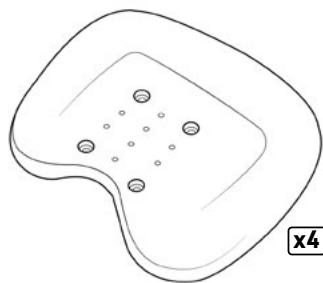

8- Upper Support Tube

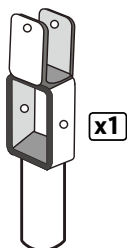

9- Lower Support Tube

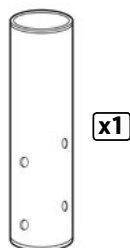

10 - M6 Bolt 20mm

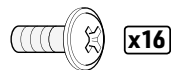

11 - M8 Bolt 65mm



12 - M8 Bolt 70mm



13 - M8 Bolt 95mm



14 - M8 Bolt 115mm



23 - Allen Wrench

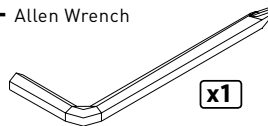

24 - Wrench

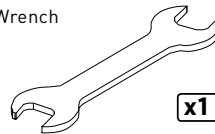

25 - Wrench 2

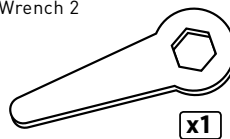

15- M8 Large Curved Washer



16- M8 Small Curved Washer



17- M8 Flat Washer



18- M6 Flat Washer



19- M8 Spring Washer

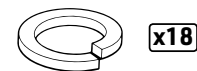

20- M6 Spring Washer



21- M8 Nut

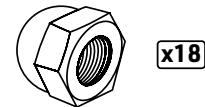

22- M6 Nut



ASSEMBLY INSTRUCTIONS

STEP 1

14 - M8 Bolt 115mm



16 - M8 Small Curved Washer



19 - M8 Spring Washer

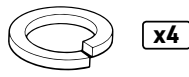

21 - M8 Nut

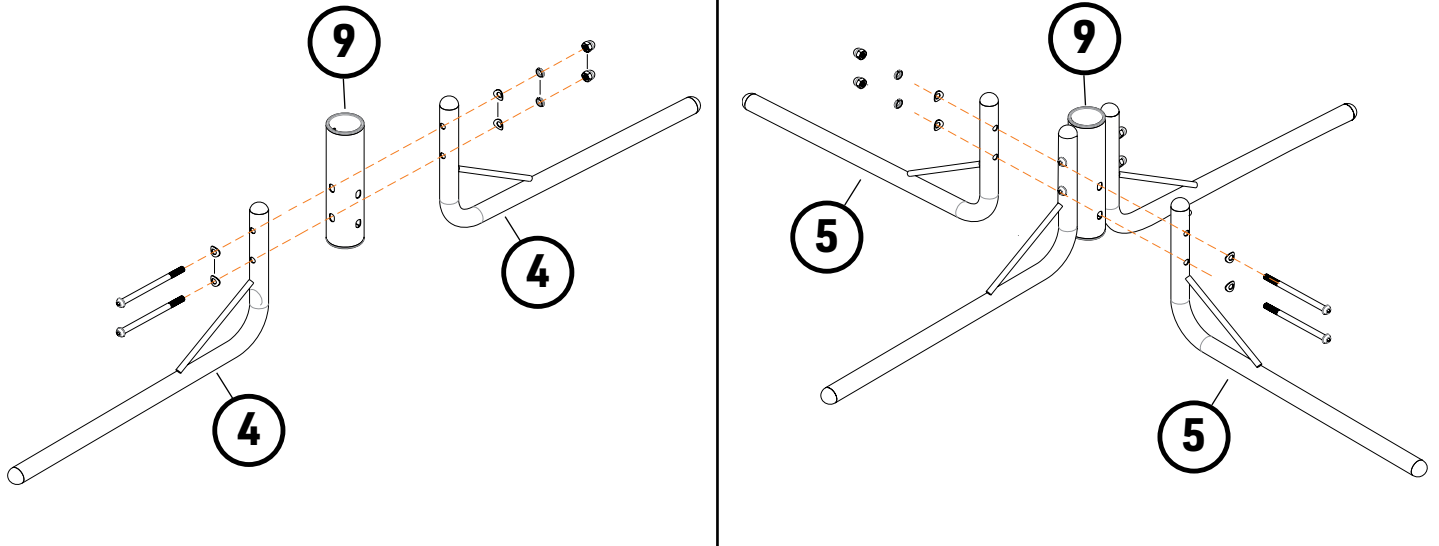
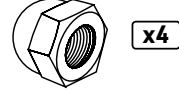

STEP 2

12 - M8 Bolt 70mm



17 - M8 Flat Washer



19 - M8 Spring Washer

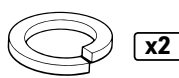

21 - M8 Nut

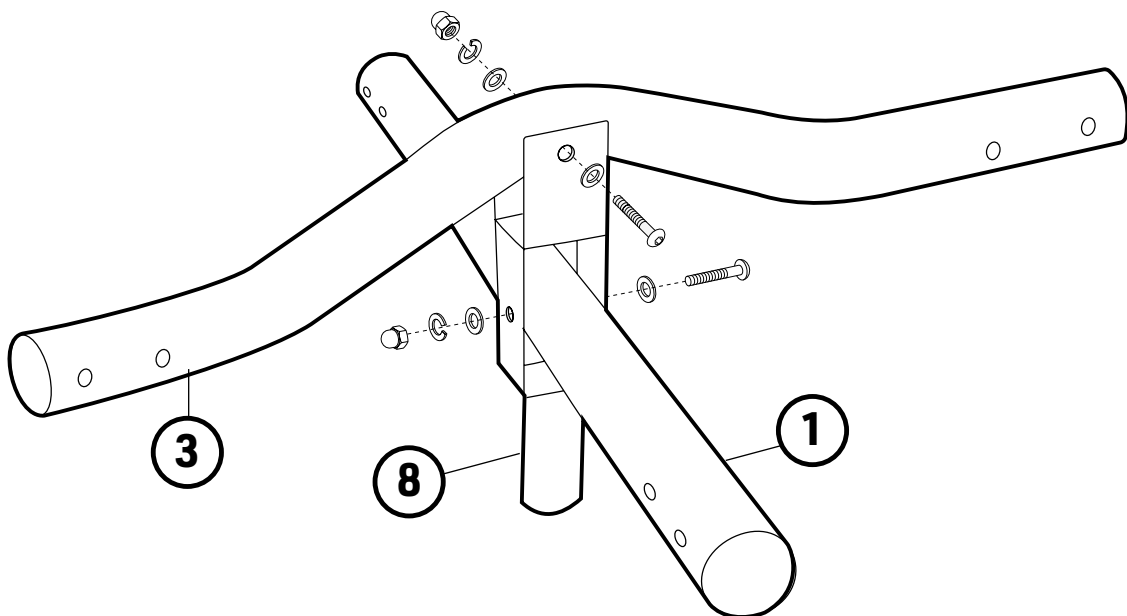

ASSEMBLY INSTRUCTIONS

STEP 3

10 - M6 Bolt 20mm

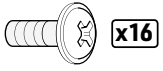

18 - M6 Flat Washer



20 - M6 Spring Washer



22 - M6 Nut

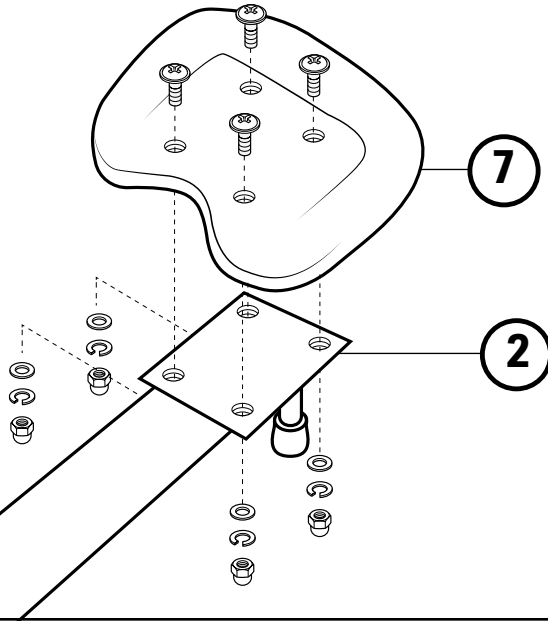

STEP 4

13 - M8 Bolt 95mm



16 - M8 Small Curved Washer



19 - M8 Spring Washer



21 - M8 Nut

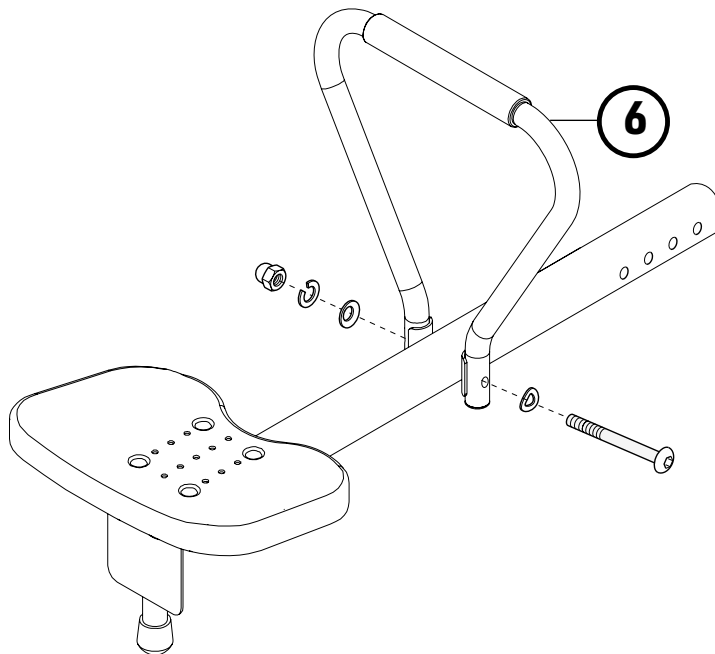

ASSEMBLY INSTRUCTIONS

STEP 5

11 - M8 Bolt 65mm



15 - M8 Large Curved Washer



19 - M8 Spring Washer

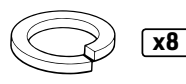

21 - M8 Nut

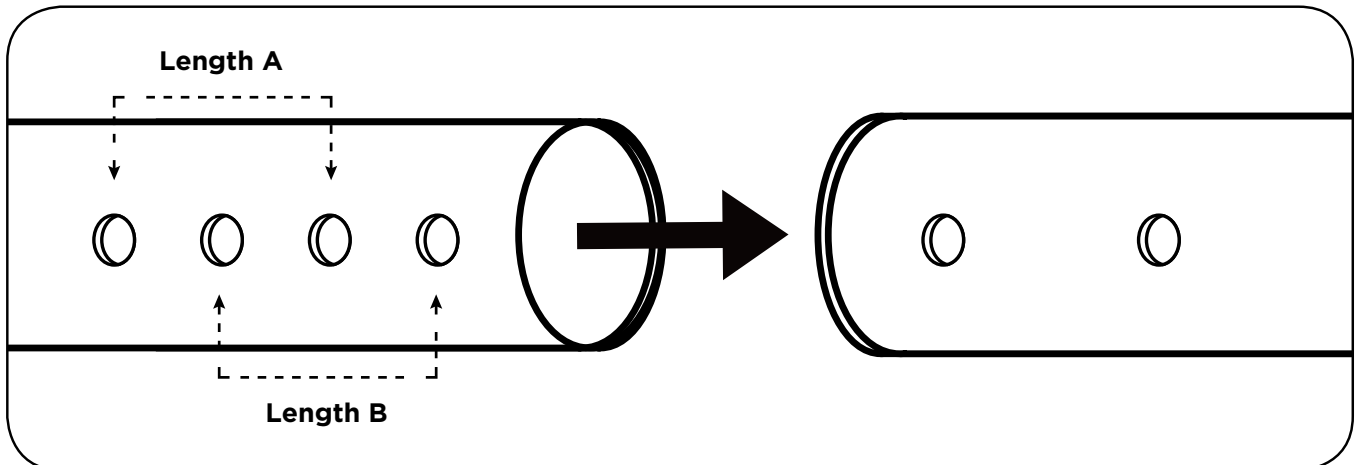
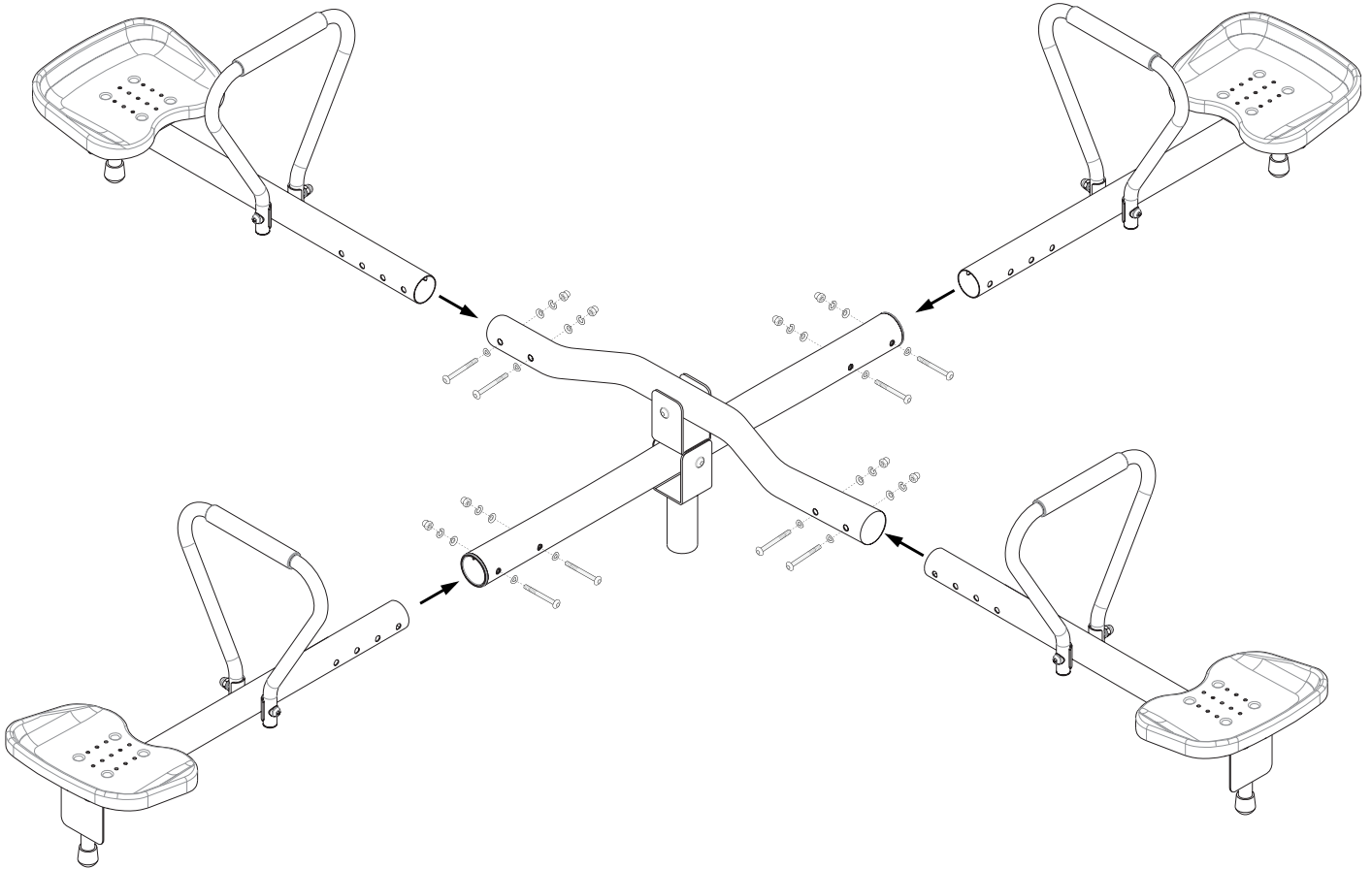
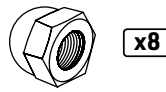

ASSEMBLY INSTRUCTIONS

STEP 7

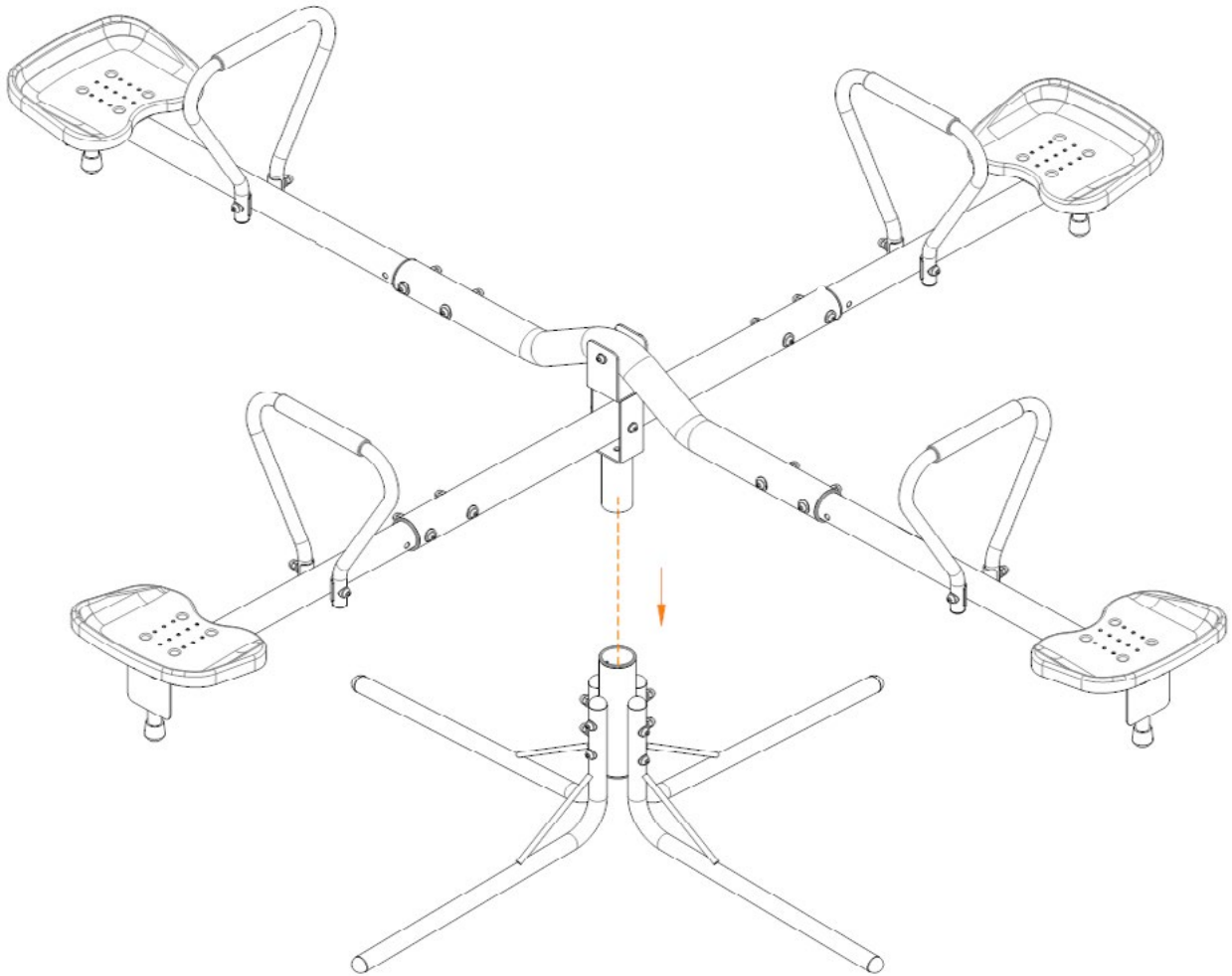

NOTES

CUSTOMER SERVICE

GQBrands®
1-866-498-5269
CustomerService@GQBrands.com
4401 Samuell Blvd, Ste 150,
Mesquite, TX 75149