

40" EXERCISE TRAMPOLINE

MODEL# 9040MT
PRODUCT MANUAL - VERSION 05.18.08

FOR AGES:

13+

WEIGHT LIMIT:

220 Lbs
100 Kgs

TO BUILD:



TOOLS NEEDED:



HOW-TO
VIDEOS ONLINE



CUSTOMER SERVICE

GQBrands.com • CustomerService@GQBrands.com • 1-866-498-5269 • 4401 Samuell Blvd, Ste 150, Mesquite, TX 75149



CUSTOMER SERVICE INFORMATION

Thank you for purchasing: **40" EXERCISE TRAMPOLINE**

MODEL# 9040MT

At GQBrands®, we want all of our customers to be completely satisfied with their purchase. Take time to review the contents of the product you have just received to make sure that all of the parts are included. If you find that any parts are missing or damaged, we will provide replacement parts at no charge within 30 days of purchase.

Please keep in mind that for select damaged part replacement requests, we will require a photo for submission.

To order these parts, or if you have any other questions or concerns about this GQBrands product, please contact us at

PureFitRx.com
Phone: 1-866-498-5269
Email: CustomerService@GQBrands.com
4401 Samuell Blvd, Ste 150, Mesquite, TX 75149

Please be sure to include the following information when you contact Customer Service:

YOUR NAME: _____

YOUR MAILING ADDRESS: _____

YOUR EMAIL ADDRESS: _____

PRODUCT NAME: _____

PRODUCT MODEL#: _____

PART NUMBER _____

RETAILER WHERE PURCHASED: _____

DATE OF PURCHASE: _____

ORDER NUMBER: *(If Available)* _____

SERIAL NUMBER: *(If Available)* _____

QUANTITY NEEDED: _____

PICTURE OF DAMAGED PART

LIMITED WARRANTY

Global Quality Brands® warrants this product to be free from defects in workmanship and materials under normal use and conditions for a period of 90 DAYS FROM THE DATE OF ORIGINAL PURCHASE. This Limited Warranty is not transferable and is available only for the original purchaser of the Product. The Company's obligation under this warranty is limited to replacing or repairing the Product, at the discretion of the company.

All warranty coverage extends only to the original retail purchaser from the date of purchase, GQ Brands obligation under this warranty is limited to replacing or repairing, at Global Quality Brands® option. All products for which a warranty claim is made must be received by Global Quality Brands® and accompanied by sufficient proof of purchase (photocopy of the original store receipt, indicating the date of purchase). All freight and handling fees are the responsibility of the consumer to pay, both to and from Global Quality Brands®. All warranty claims must be preauthorized by Global Quality Brands® pre-authorization can be obtained by calling 866-498-5269.

This warranty does not cover ordinary wear and tear, weathering, failure to follow directions, improper installation, improper maintenance, or acts of nature, (such as damage caused by wind, lightning, snow, water, or ice) weather damage, damage caused by unauthorized repair work or damage caused by improper use of the products are not covered by the product warranty. No other warranty beyond that specifically set forth above is authorized by GQBrands®.

GLOBAL QUALITY BRANDS® IS NOT RESPONSIBLE OR LIABLE FOR INDIRECT, SPECIAL OR CONSEQUENTIAL DAMAGES ARISING OUT OF OR IN CONNECTION WITH THE USE OR PERFORMANCE OF THE PRODUCT OR OTHER DAMAGES WITH RESPECT TO ANY ECONOMIC LOSS, LOSS OF PROPERTY, LOSS OF REVENUE OR PROFITS, LOSS OF ENJOYMENT OR USE, COST OF REMOVAL, INSTALLATION OR OTHER CONSEQUENTIAL DAMAGES. SOME STATES DO NOT ALLOW THE EXCLUSION OR LIMITATION OF INCIDENTAL OR CONSEQUENTIAL DAMAGES. ACCORDINGLY,

THE ABOVE LIMITATION MAY NOT APPLY TO YOU. THE WARRANTY EXTENDED HEREUNDER IS IN LIEU OF ALL OTHER WARRANTIES AND GLOBAL QUALITY BRANDS®, SPECIFICALLY DISCLAIMS ANY IMPLIED WARRANTY OF MERCHANTABILITY OR FITNESS FOR A PARTICULAR PURPOSE IS LIMITED IN ITS SCOPE AND DURATION TO THE TERMS SET FORTH HEREIN. SOME STATES DO NOT ALLOW LIMITATION ON HOW LONG AN IMPLIED WARRANTY LASTS. ACCORDINGLY, THE ABOVE LIMITATION MAY NO APPLY TO YOU. THIS WARRANTY GIVES YOU SPECIFIC LEGAL RIGHTS. YOU MAY ALSO HAVE OTHER RIGHTS, WHICH VARY FROM STATE TO STATE.

WHILE EVERY ATTEMPT IS MADE TO ENSURE THE HIGHEST DEGREE OF PROTECTION IN ALL EQUIPMENT, WE CANNOT GUARANTEE FREEDOM OF INJURY. THE USER ASSUMES ALL RISK OF INJURY DUE TO USE. ALL MERCHANDISE IS SOLD ON THIS CONDITION, WHICH NO REPRESENTATIVE OF GQBRANDS® CAN WAIVE OR CHANGE.



LIMITED WARRANTY



ADULT ASSEMBLY REQUIRED **CHOKING HAZARD - Small Parts** **NOT for children under 3 years of age.**

Please read these warnings and the information in this manual in its entirety.

Failure to comply with the following instructions may increase the risk of serious injury and/or death:

- This unit is designed only for jogging in place and similar bounding exercises.
- Not recommended for children under 13 years of age.
- Maximum weight limit: 220lbs. (100kgs)
- Children under 13 **MUST NEVER** use the trampoline unless supervised by a responsible adult with knowledge of trampoline use. **DO NOT** leave children unattended at any time.
- Caution and care must be taken in underneath a light or ceiling fan.
- The contents are not suitable for children under 3 years of age. This product contains small parts, which may cause choking.
- This trampoline is designed for one user only. Do not let more than one person use this product at the same time.
- Immediately discontinue use if any breakage to the frame assembly or springs are found. Failure to do this may result injury and/or further damage to the product.
- This trampoline is only designed for normal residential use. It is **NOT** intended for commercial applications and/or in public areas such as schools, parks, day cares, commercial/communal gyms, etc.
- When in use, your trampoline must be placed at a safe distance from any vertical or horizontal obstructions, such as stairways/ stairwells, power lines, ceiling fans, pools, walls, overhead or wall light fixtures, windows, furniture, appliances, etc. Keep on a level surface.
- **DO NOT** store trampoline outdoors or where exposed to moisture or extreme temperatures.
- Ensure area under and around trampoline is clear of any toys/obstacles that may cause injury.
- **DO NOT** wear glasses or helmets when using the trampoline.
- **DO NOT** store items, playthings, or place any obstructions underneath the trampoline mat.
- Users should not wear clothing, jewelry, or anything could catch or snag on the product (e.g. loose clothing, cords, shoulder bags).
- **DO NOT** fall or bounce on your knees. This can cause injury.
- **DO NOT** somersault. This can cause serious injury, paralysis, or death.
- **DO NOT** allow infants or animals to crawl underneath the trampoline mat.
- **DO NOT** use or allow use of the trampoline under the influence of any substance or medication which may impair the supervisor's or jumper's judgment and/or coordination.
- Users should stand or bounce as near to the center of the mat as possible. Bouncing or standing near the edge of the trampoline could cause the frame to tip over or damage the mat/springs.
- Do not allow small children to wander into the play area where the trampoline is in use.
- **ALWAYS** secure the trampoline against unauthorized and unsupervised use.
- Before each use, inspect and replace any worn, defective or missing parts. It is important to check the trampoline to ensure the frame is steady and all parts are in good condition.
- Before each use, make sure the frame padding is in place with the springs and frame fully covered.
- **ALWAYS** make sure to store your trampoline safely, where it will not present a tripping or obstacle hazard.
- Dispose of all packaging materials safely and per local ordinance.
- Make sure the trampoline is placed on a stable and leveled surface.
- Make sure there are no obstructions above, beneath, or around the trampoline. In the interest of your safety, it is important that you read both the safety notice and the assembly instructions carefully before using or allowing use of this product.
- Ensure the feet are firmly secured and the frame pad covers the springs before each use.
- If you do not follow these guidelines, the user acknowledges responsibility for the increased risk of serious injury.
- The recommended overhead clearance is a minimum of 10 feet from any and all ceilings, overhead cables, ceiling fixtures or hard surfaces. In terms of horizontal clearance, ensure that potentially hazardous objects and conditions are located at a recommended minimum of 15 feet away from the trampoline (including but not limited to: electric cables, roadways, outdoor equipment, furniture, appliances, vehicles, lighting, walls, tree limbs, shelving, any overhangs, etc.) and no potentially hazardous conditions exist nearby (including but not limited to: stairwells, pools/hot tubs, any bodies of water, uneven or drop-off ground levels, etc.)

PARTS LIST

Part #	Description	QTY	Part#	Description	QTY
1	Frame	x1	7	Nut	x12
2	Jumping Mat	x1	8	Washer	x6
3	Spring	x32	9	Frame Pad	x1
4	W-Hook	x16	10	Leg with Cap	x6
5	T-Section Piece	x12	11	Large Square Washer	x6
6	40mm Square Neck Bolts	x12	-	-	-

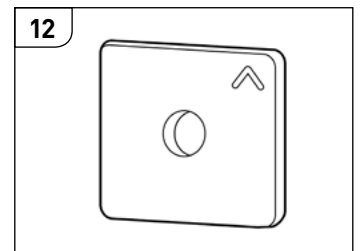
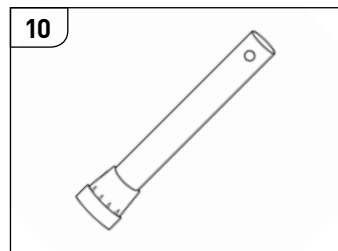
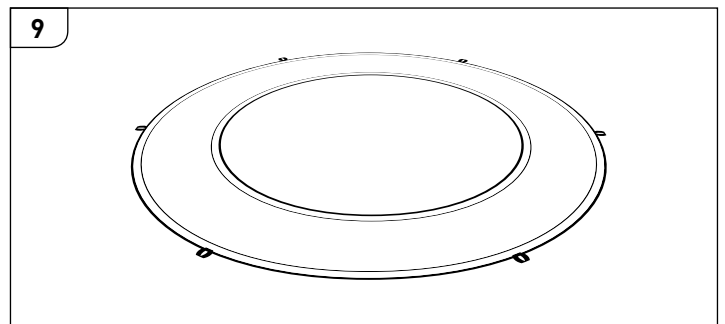
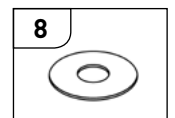
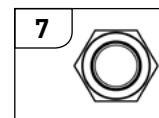
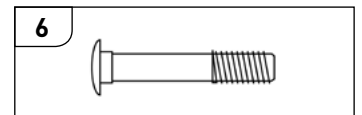
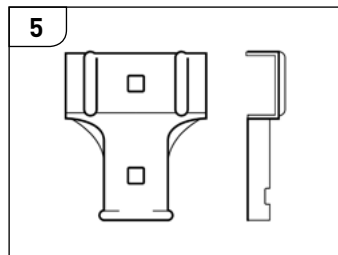
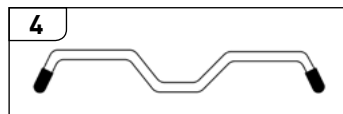
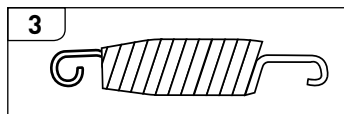
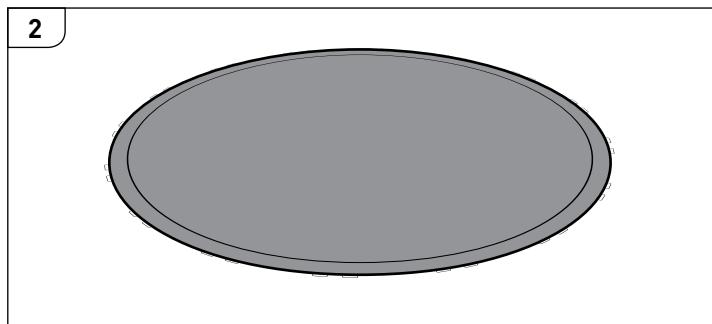
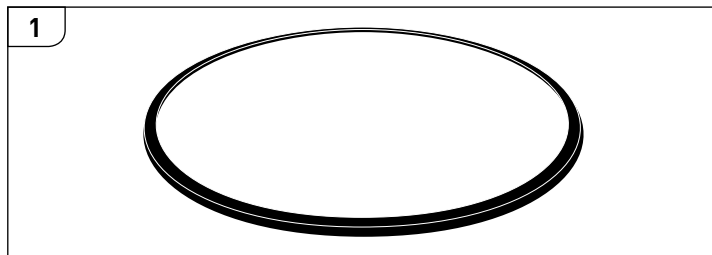

ASSEMBLY INSTRUCTIONS

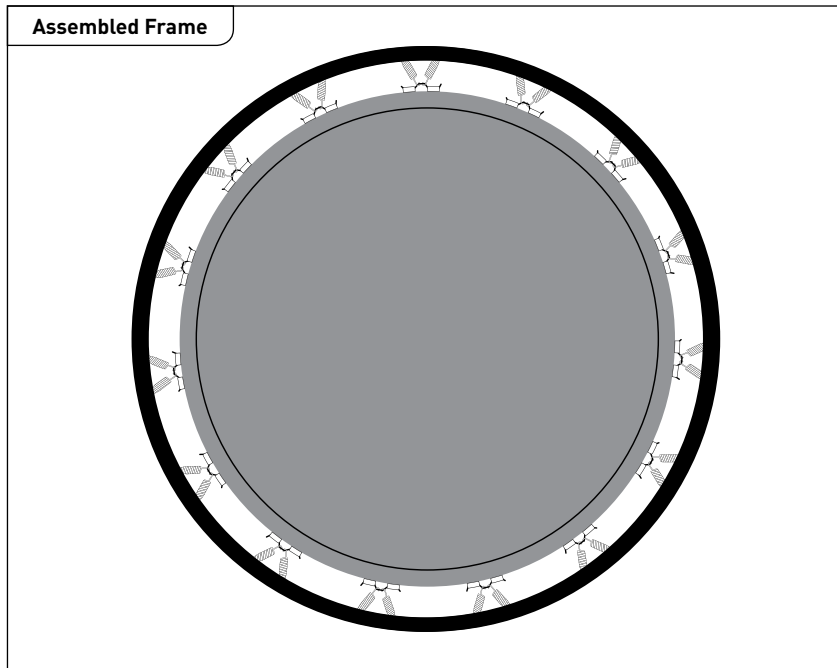

STEP 1:

NOTE:

The Frame Pad (Part 9) may be already attached to the Frame, remove it and place it aside until Step 3

The Frame (Part 1), Jumping Mat (Part 2), Springs (Part 3), & W-Hooks (Part 4) should be assembled in one piece.

Place assembled Frame on an even, clean, & flat surface to install. Make sure that there are no obstructions in your way when building the Mini Trampoline.

NOTE:

Make sure that the spring ends are facing up, and the logo printed on the Jumping Mat is facing the floor.

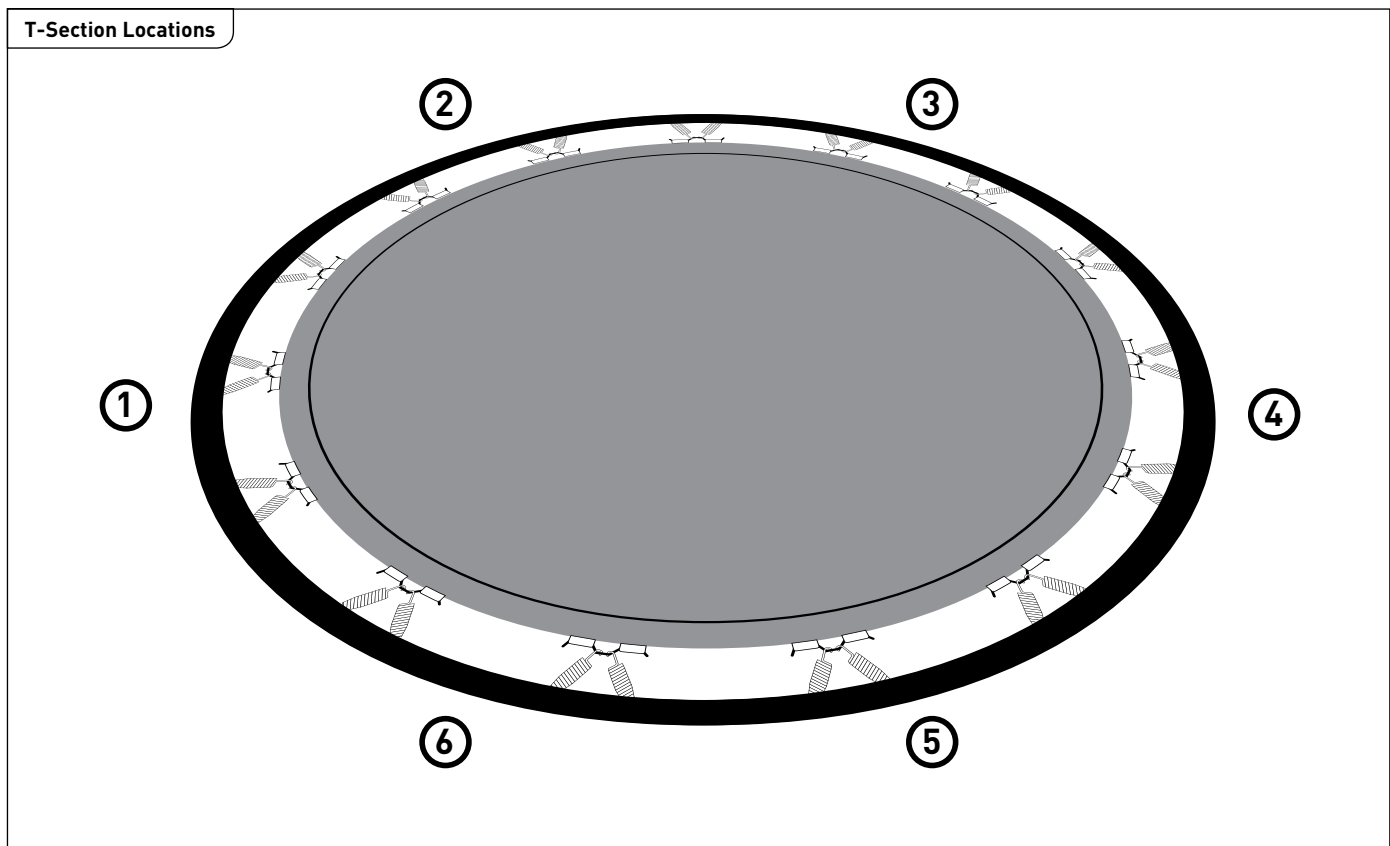

ASSEMBLY INSTRUCTIONS

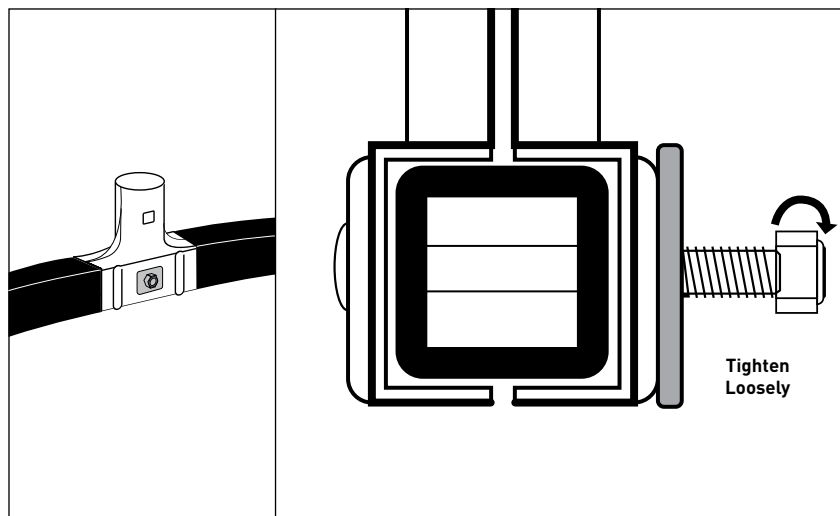
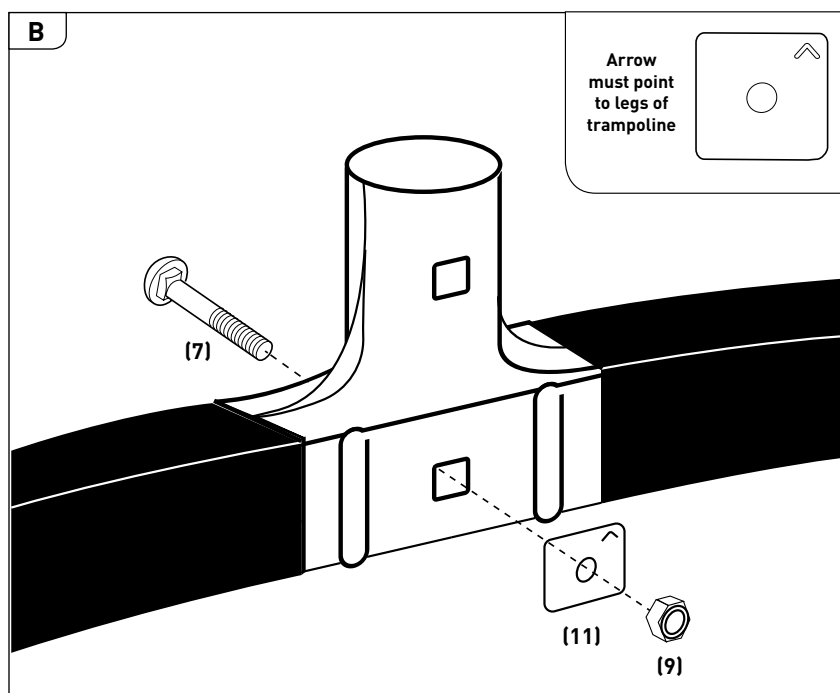
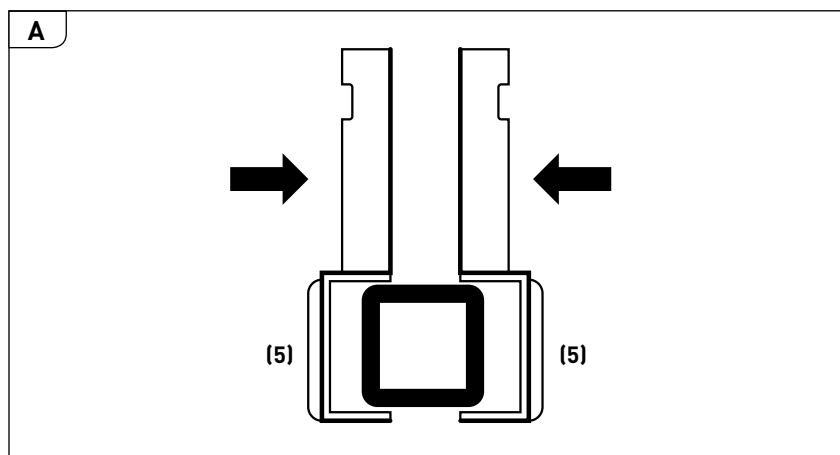

STEP 2:

Parts:

- Part 5 (x12) - T-Section Pieces
- Part 6 (x6) - 40mm Square Neck Bolts
- Part 7 (x6) - Nuts
- Part 11 (x6) - Large Square Washer

Locate the six T-Section openings in the frame (Shown in page 5) to begin installing the T-Sections Pieces into the Frame.

- Place a T-Section Piece on the outside of the frame and the other half from the inside of the Frame. Make sure that the T-Sections are facing up to install the legs in **Step 5**.
- Insert a Bolt (Part 6) from the outside of the frame to show the smooth surface, between both T-Section Pieces. Secure with a Nut (Part 7) and a Large Square Washer (Part 11) loosely to allow the legs to slide in.
- Continue to install all T-Sections in the remainder of the openings of the frame.

ASSEMBLY INSTRUCTIONS

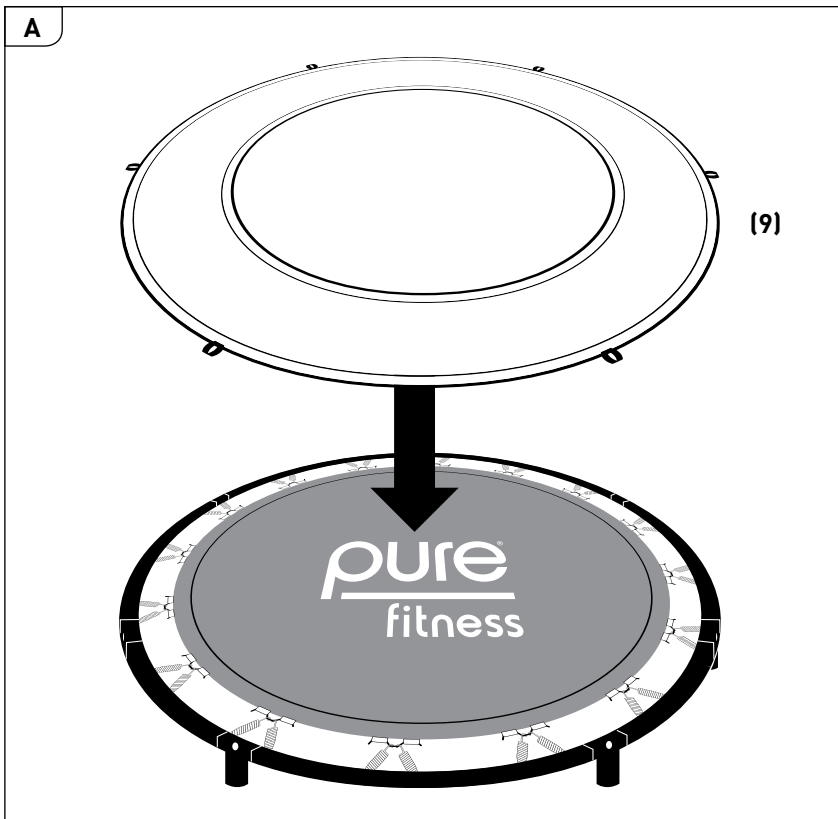

STEP 3:

A. Flip the Frame & Jump Mat in order to place the Frame Pad (Part 9).

Make sure to locate all six loops in the Frame Pad. Line them up to all T-Sections inserts.

B. Hook all loops in the inserts openings of the T-sections before installing the legs.

Once the Frame Pad is placed and snug, flip the frame again so the Jump Mat faces the ground to begin installation of the legs.

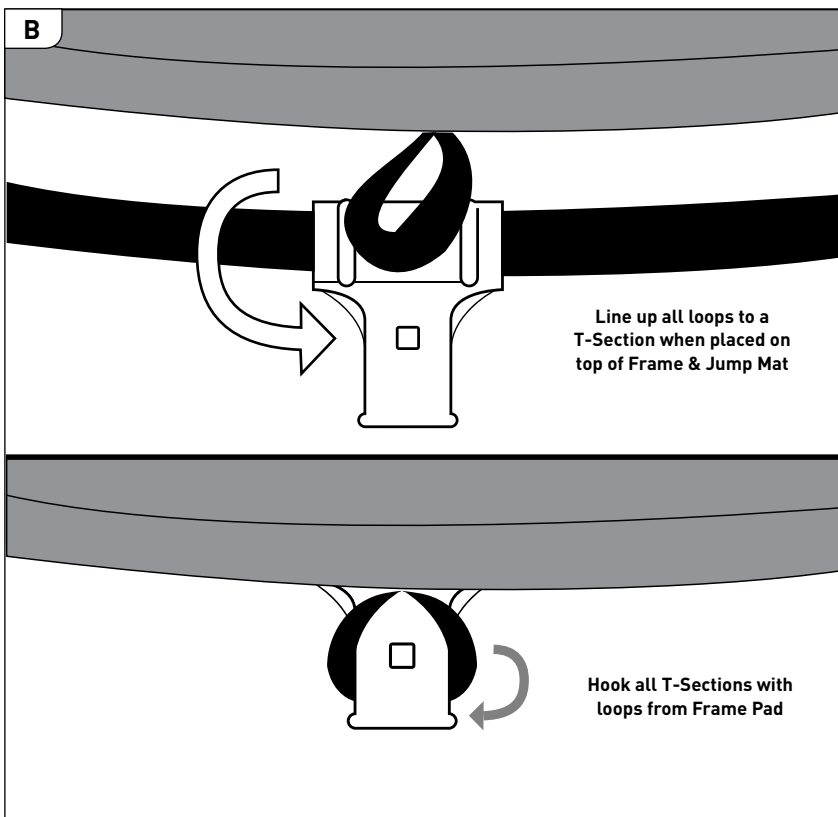

ASSEMBLY INSTRUCTIONS

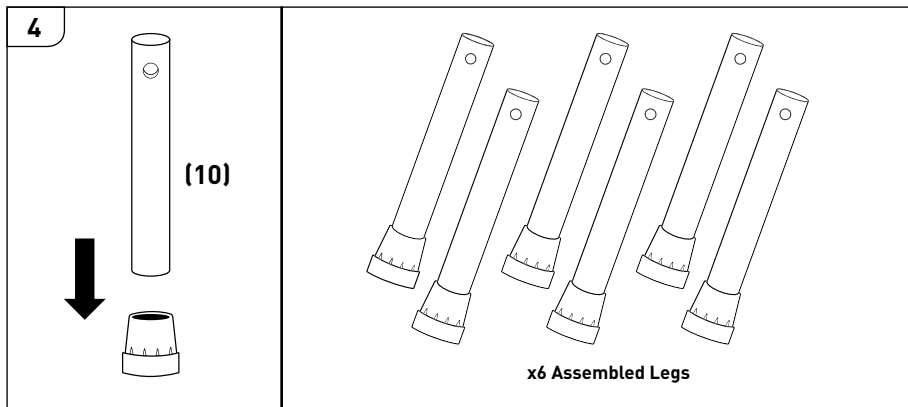

STEP 4:

NOTE: If the Caps from the Leg Poles are not already placed after unboxing, make sure to insert them on the opposite side of where the openings are located.

Repeat this process until you have all six assembled Legs with Caps (Part 10).

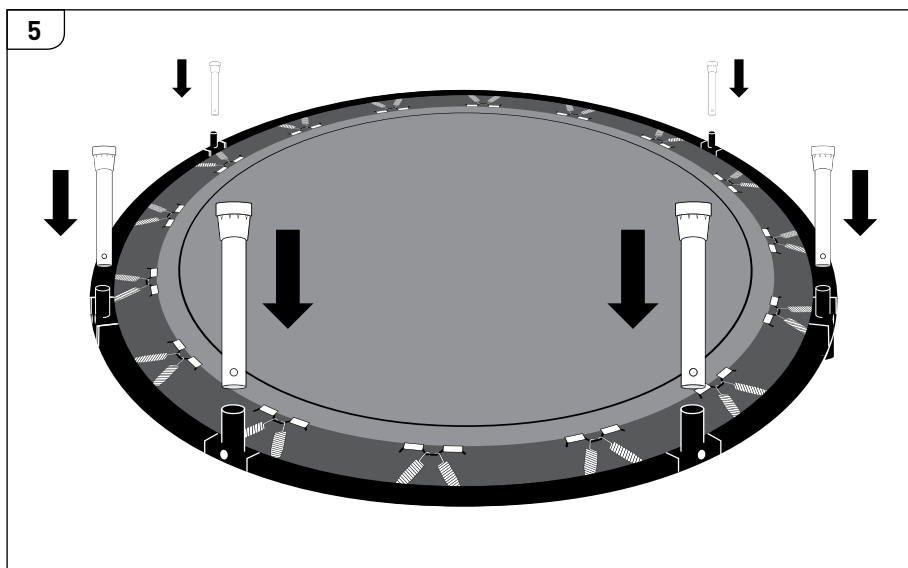

STEP 5:

Parts:

- Part 6 (x6) - 40mm Square Neck Bolts
- Part 7 (x6) - Nuts
- Part 8 (x6) - Washers
- Part 10 (x6) - Leg with Caps

A. Place all assembled legs inside the inserts of the T section. Align openings from the T-Sections and Legs.

Insert a Bolt (Part 6) from the outside of the Frame and secure with a Washer (Part 8) and Nut (Part 7). Make sure Bolt is fully inserted.

B. Repeat this process until all legs are installed properly and securely. You may now fully tighten all Nuts on the trampoline.

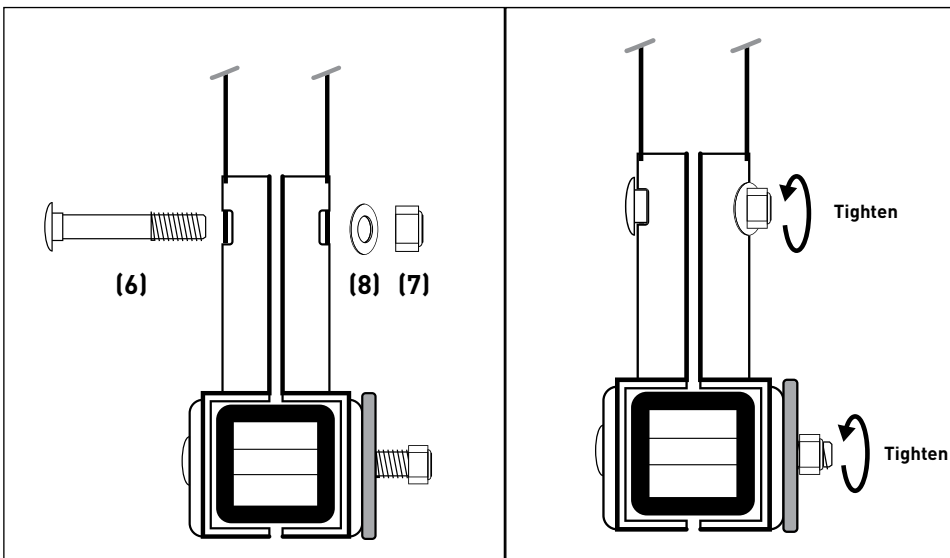

STEP 6:

Flip the Mini-Trampoline over. Inspect that all parts are properly installed before use and place in a safe and open area.