



DURA-BOUNCE 12FT TRAMPOLINE

MODEL# 9312TS
PRODUCT MANUAL - VERSION 01.18.05

FOR AGES:

6+

WEIGHT LIMIT:

350 Lbs
159 Kgs

ADULT(S) NEEDED:



TOOLS NEEDED:



WARNING/ADVERTENCIA

- Do not allow more than one person on the trampoline at any time.
- Do not allow small children to use unless supervised by an adult.
- ADULT ASSEMBLY REQUIRED.
- The contents of this package are not suitable for children under 3 years of age. Contains small parts which may cause choking.
- Consult a physician before beginning any exercise program or strenuous activity.

CUSTOMER SERVICE

-  GQBrands.com
-  CustomerService@gqbrands.com
-  1-866-498-5269
-  4401 Samuell Blvd, Ste 150
Mesquite, TX 75149

CUSTOMER SERVICE INFORMATION

Thank you for purchasing: **DURA-BOUNCE 12FT TRAMPOLINE**

MODEL# 9312TS

At Global Quality Brands®, we want all of our customers to be completely satisfied with their purchase. Please take time to review the contents of the product you have just received to make sure that all of the parts are included. If you find that any parts are missing or damaged, we will happily provide replacement parts at no charge within 30 days of purchase.

Please keep in mind that for select damaged part replacement requests, we will require a photo for submission.

If you request replacement parts, please be sure to include the following information in your correspondence:

To order these parts, or if you have any other questions or concerns about this GQ Brands product, please contact us at

PureFun.net
Global Quality Brands®
Phone: 1-866-498-5269
Email: customerservice@gqbrands.com
4401 Samuell Blvd, Ste 150
Mesquite, TX 75149

Sincerely,
Customer Service

YOUR NAME:

YOUR MAILING ADDRESS:

YOUR EMAIL ADDRESS:

PRODUCT NAME:

PRODUCT MODEL #:

PART # (Located In Manual)

RETAILER WHERE YOU PURCHASED PRODUCT:

DATE OF PURCHASE:

ORDER # (If Available)

SERIAL#:

QUANTITY NEEDED:

PICTURE OF DAMAGED PART(s) SUBMIT VIA Email, Fax, or Mail

LIMITED WARRANTY

Global Quality Brands® warrants this product to be free from defects in workmanship and materials under normal use and conditions for a period of ONE YEAR FROM THE DATE OF ORIGINAL PURCHASE. This Limited Warranty is not transferable and is available only for the original purchaser of the Product. The Company's obligation under this warranty is limited to replacing or repairing the Product, at the discretion of the company.

All warranty coverage extends only to the original retail purchaser from the date of purchase, GQ Brands obligation under this warranty is limited to replacing or repairing, at Global Quality Brands® option. All products for which a warranty claim is made must be received by Global Quality Brands® and accompanied by sufficient proof of purchase (photocopy of the original store receipt, indicating the date of purchase). All freight and handling fees are the responsibility of the consumer to pay, both to and from Global Quality Brands®. All warranty claims must be preauthorized by Global Quality Brands® pre-authorization can be obtained by calling 866-498-5269.

This warranty does not cover ordinary wear and tear, weathering, failure to follow directions, improper installation, improper maintenance, or acts of nature, (such as damage caused by wind, lightning, snow, water, or ice) weather damage, damage caused by unauthorized repair work or damage caused by improper use of the products are not covered by the product warranty. No other warranty beyond that specifically set forth above is authorized by GQBrands®.

GLOBAL QUALITY BRANDS® IS NOT RESPONSIBLE OR LIABLE FOR INDIRECT, SPECIAL OR CONSEQUENTIAL DAMAGES ARISING OUT OF OR IN CONNECTION WITH THE USE OR PERFORMANCE OF THE PRODUCT OR OTHER DAMAGES WITH RESPECT TO ANY ECONOMIC LOSS, LOSS OF PROPERTY, LOSS OF REVENUE OR PROFITS, LOSS OF ENJOYMENT OR USE, COST OF REMOVAL, INSTALLATION OR OTHER CONSEQUENTIAL DAMAGES. SOME STATES DO NOT ALLOW THE EXCLUSION OR LIMITATION OF INCIDENTAL OR CONSEQUENTIAL DAMAGES. ACCORDINGLY, THE ABOVE LIMITATION MAY NOT APPLY TO YOU. THE WARRANTY EXTENDED HEREUNDER IS IN LIEU OF ALL OTHER WARRANTIES AND GLOBAL QUALITY BRANDS®, SPECIFICALLY DISCLAIMS ANY IMPLIED WARRANTY OF MERCHANTABILITY OR FITNESS FOR A PARTICULAR PURPOSE IS LIMITED IN ITS SCOPE AND DURATION TO THE TERMS SET FORTH HEREIN. SOME STATES DO NOT ALLOW LIMITATION ON HOW LONG AN IMPLIED WARRANTY LASTS. ACCORDINGLY, THE ABOVE LIMITATION MAY NO APPLY TO YOU. THIS WARRANTY GIVES YOU SPECIFIC LEGAL RIGHTS. YOU MAY ALSO HAVE OTHER RIGHTS, WHICH VARY FROM STATE TO STATE.

WHILE EVERY ATTEMPT IS MADE TO ENSURE THE HIGHEST DEGREE OF PROTECTION IN ALL EQUIPMENT, WE CANNOT GUARANTEE FREEDOM OF INJURY. THE USER ASSUMES ALL RISK OF INJURY DUE TO USE. ALL MERCHANDISE IS SOLD ON THIS CONDITION, WHICH NO REPRESENTATIVE OF GQ BRANDS® CAN WAIVE OR CHANGE.



IMPORTANT MESSAGE

WARNING - PLEASE READ

ADULT ASSEMBLY REQUIRED

CHOKING HAZARD - Small Parts

NOT for children under 3 years of age.

WARNING:

While every attempt is made to ensure the highest degree of protection in all equipment, we cannot guarantee freedom from injury. The user assumes all risks of injury due to use. All merchandise is sold on this condition, which no representative of the company can waive or change.

WARNINGS

Please read these warnings and the information in this manual in its entirety.

Failure to comply with the following instructions may increase the risk of serious injury and/or death:

- Ensure the trampoline has been assembled correctly, per the instructions in the manual.
- It is essential that the intended site for this trampoline is completely flat and level. If the ground is not level this will cause movement in the frame and could cause stress on the joined sections.
- Before each use of this product, inspect the entire assembly and replace any worn, defective or missing parts.
- It is only recommended for use by children 6+ years of age.
- DO NOT exceed the recommended MAXIMUM WEIGHT limit of 350lbs (159kgs).
- DO NOT allow more than one person on the trampoline at a time.
- DO NOT wear glasses or helmets when using the trampoline.
- DO NOT use the trampoline in wet, windy or other adverse weather conditions. Use only when the trampoline mat is clean, dry, and safe of obstructions.
- DO NOT somersault or perform flips. This can cause serious injury, resulting in paralysis or death.
- DO NOT use the trampoline as a springboard to or from other objects. NEVER jump from or attempt to jump to other objects, bodies of water, buildings or surfaces, or into or over the trampoline enclosure.
- DO NOT allow other persons to go under, sit, stand or lie on the trampoline or the frame pads while the trampoline is in use.
- DO NOT use the trampoline set when under the influence of alcohol, drugs or medication which may impair the jumper's judgment and coordination.
- ALWAYS remove jewelry, belt buckles or any other sharp objects before using the trampoline.
- ALWAYS jump in the center of the trampoline mat.
- ALWAYS secure the trampoline against unauthorized and unsupervised use.
- NEVER wear footwear (e.g. shoes) when using the trampoline. ALWAYS wear socks when using the trampoline.
- Children MUST NEVER use the trampoline unless supervised by a responsible adult with knowledge of trampoline use.
- Children MUST NEVER be left unattended at any time.
- Ensure the trampoline set is on level ground with a minimum of 8 feet (2.5M) clear space around the sides, 26 feet (8M) clear height space above and that no obstructions are under the trampoline.
- ALWAYS watch for power lines, overhead cabling, and other hazards or obstructions above, around and below the location where you are installing your trampoline set. Failure to do so can result in serious injury, death, and property damage.
- Mount and dismount from the trampoline and enclosure with care as injury may result. Children should be assisted when entering and exiting the trampoline to reduce the risk of falling.
- The frame of your trampoline set is made of steel and it will conduct electricity. No electrical equipment (lights, heaters, etc.) should be permitted on or around the trampoline under any circumstance.
- Please read and refer to other warnings and use information in the trampoline instructions before use.
- Dispose of all packaging materials safely and per local ordinance. This Safety

CARE AND USE

- This trampoline must be assembled by adults. It must be erected exactly as detailed in the assembly instructions. Two adults are required to assemble this trampoline. This product should only be used by children over the age of 6. Please ensure children under the age of 3 years old do not play with or are given any part of this trampoline when being assembled or when complete as it contains small parts which may pose a choking hazard.
- Please take care during assembly, as the manufacturing process can sometimes result in the occasional sharp edge and small pieces of waste metalwork. The use of gloves to protect your hands from pinch points during assembly is also strongly recommended. Should there be any missing parts, the trampoline must not be used until replacement parts have been fitted.
- The frame pad should always be fitted properly, fully covering the trampoline frame and springs.
- Your trampoline must be placed on a flat and level surface which is well lit. Under no circumstances should it be positioned on a hard surface such as concrete or asphalt, unless the ground under the trampoline plus the recommended free space area is covered with a safety surface. Examples of suitable surfaces are grass, sand or a play surface intended for this trampoline. It is important not to place or store anything under your trampoline.
- This trampoline is designed and made for family domestic use only within the recommended weight limit of 350lbs (159kgs). This trampoline is not intended for use outside of these guidelines. The user must remove footwear (shoes) before use. The user must wear socks when using the trampoline. Misuse can result in injury. Inspect the trampoline before use and always replace worn, defective or missing parts.

SAFETY INFORMATION

- **Safety Information:** This trampoline is designed and manufactured to provide you and your family with many years of fun and exercise, but for your benefit and safety, please read this manual carefully and in full before assembling and using your trampoline.
- **DO NOT** allow more than one (1) person on the trampoline at a time. Multiple jumpers increase the chance of someone becoming injured. Jumpers may collide with one another, fall off the trampoline, fall on or through the springs or land incorrectly on the mat. Multiple jumpers increase the chances of loss of control, collision and falling off. This can result in severe injury or death.
- Always secure the trampoline against unauthorized and unsupervised use.
- Trampolines are rebounding devices which propel the user to unaccustomed heights and into a variety of body movements. Rebounding off of the trampoline, striking the frame or springs, or improperly landing on the trampoline mat (bed) may cause injury.
- The frame of your trampoline is made of steel and it will conduct electricity. No electrical equipment (lights, heaters, extension cords, household appliances, etc.) should be permitted on or around the equipment under any circumstances to avoid the risk of electrocution.
- As your trampoline mat is raised off the ground, there is the risk of falling when entering or exiting the trampoline. Children should be assisted when entering and exiting the trampoline to reduce their risk of falling.
- Do not flip, somersault or perform maneuvers which may cause you to land on the head or neck. Paralysis or death can result even if you land in the middle of the trampoline mat.
- **IMPORTANT:**
You must not use the trampoline if you have a medical history of neck or back injuries or certain mental or physical conditions – an existing condition dramatically increases the risk of serious injury or death.
- No modification should be carried out to the trampoline or any of its components. Any modification could lead to damage to the product or result in a personal injury.
- **WEATHER CONDITIONS:**
Special care should be taken as weather conditions change. In particular, a wet trampoline mat (bed) is too slippery for safe jumping. Gusty or severe winds can cause jumpers to lose control. To reduce the chance of injury, use the trampoline only under appropriate weather conditions. In cold weather, tongues and lips can stick to metal at sub zero temperatures. In warmer and sunnier weather, parts can become extremely hot, and the temperature should be regularly checked during play, especially metal parts.
- **HIGH WINDS:**
It is possible for the Trampoline to be blown about by high wind. If you anticipate high winds, the Trampoline must be moved to a sheltered location, or be disassembled. Pure Fun™ is not responsible for any damage to property or product resulting from wind or extreme weather. You can purchase an ANCHOR KIT for your trampoline from Pure Fun, by visiting us on the web at: **www.PureFun.Net**

ASSEMBLY WARNINGS

- The minimum overhead clearance required is 26 feet (8 meters). Ensure that no hazards or obstructions are near the trampoline such as tree branches, swing sets, swimming pools, electrical power wires, walls, fences, roof overhangs etc.
- Please be aware of the following when selecting a place for your trampoline:
 - Trampoline must be placed on a level surface.
 - All obstructions from overhead, underneath or around the trampoline must be removed.
 - Do not use this trampoline indoors.
 - Do not use this trampoline on any slippery/smooth floor surface, uneven or sloping ground surface.
 - Do not place the trampoline on hard surfaces, such as asphalt, stone, concrete etc, as this can damage the frame.
- You increase the risk of serious injury and/or death if you do not follow these guidelines.
- The area must be well lit.
- When you are ready to start, make sure that you have the correct tools at hand, and adequate space for assembly.
- Please refer to the table for part descriptions and numbers. The assembly instruction uses these descriptions and numbers as reference. Make sure you have all parts listed. If you are missing any parts, please contact our customer service.

PARTS LIST

Part #	Description	QTY	Part#	Description	QTY
1	Jumping Mat	x1	6	Leg Extension	x12
2	Curved Top Rail	x12	7	U Shaped Leg	x6
3	T-Section	x12	8	Screw	x12
4	M8 Bolt	x12	9	Spring	x72
5	M6 Bolt	x12	10	Frame Pad	x1

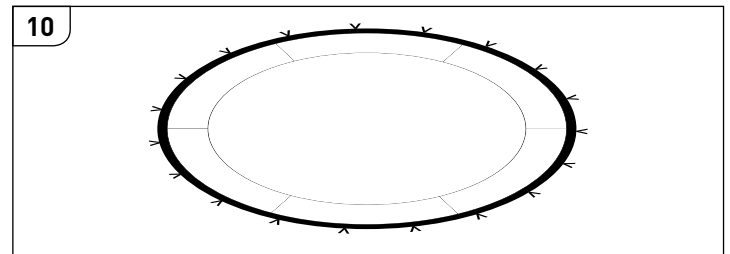
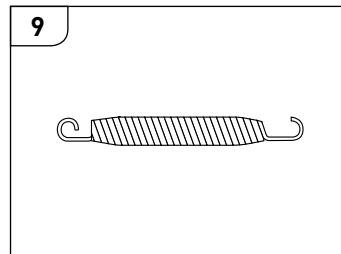
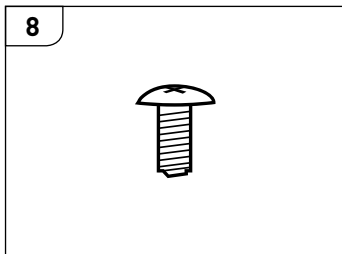
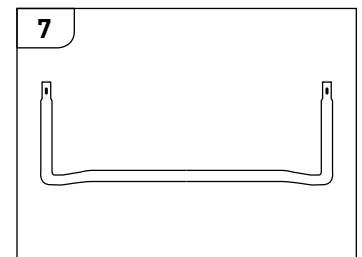
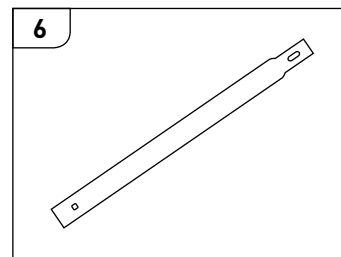
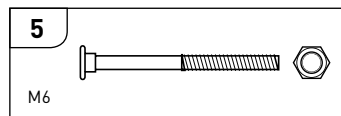
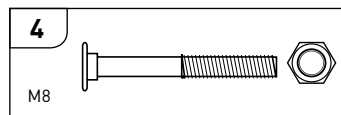
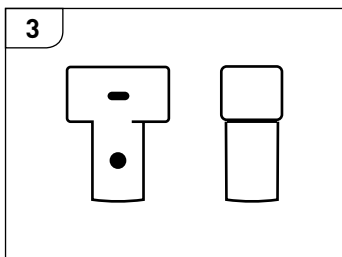
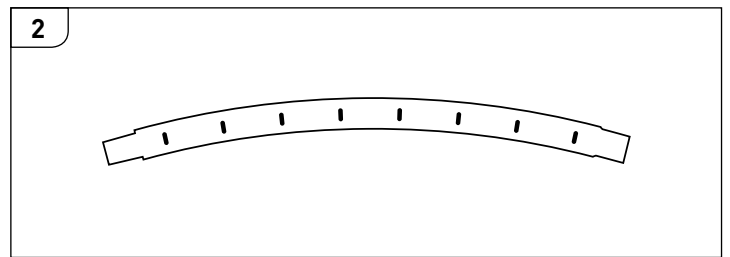
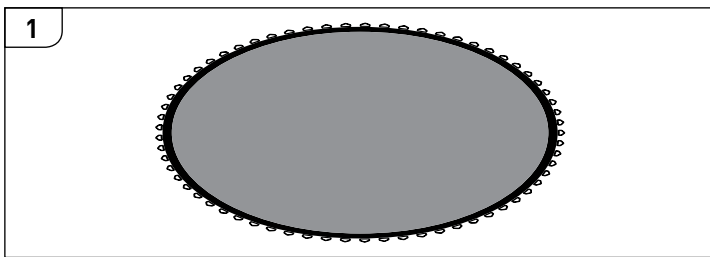

ASSEMBLY INSTRUCTIONS

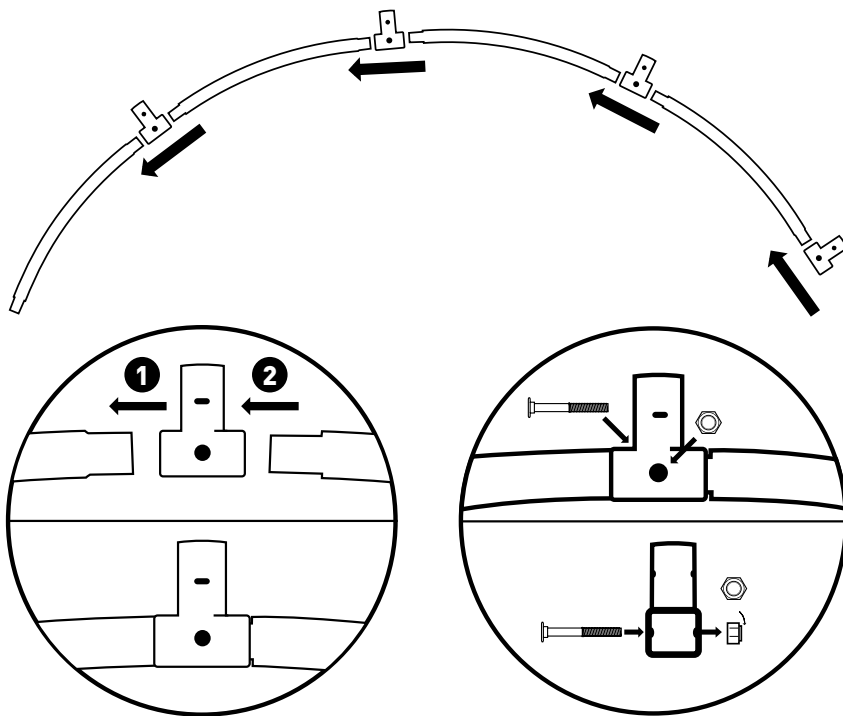

STEP 1:

Gather all 12 Curved Top Rails (Part 2), flip them over so the spring holes are touching the floor. Separate them into 3 groups of 4 Top Rails. Make sure to place them all on a flat and secure surface before you begin.

NOTE:

The Curved Top Rail has spring holes in the top section. The bottom should be smooth.

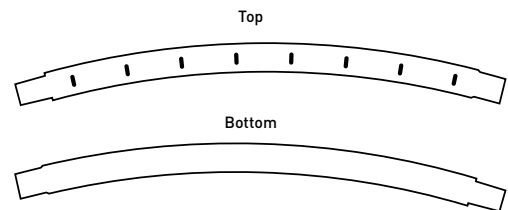

Connect both ends of the Top Rail by attaching to the T-Section (Part 3)

STEP 2:

Secure all 3 parts by screwing M8 Bolt (Part 4) with the Nut facing toward the center of the trampoline.

STEP 3:

Once you have created 3 groups, place them on a safe and flat floor as shown.

NOTE:

Openings on the top rail must remain facing the floor until Step 7 when you are ready to flip them over.

NOTE:

Do not screw in M8* Bolt and Nut on the T-Section until Step 7, this will allow you to insert all 3 groups together once the U-Shaped Legs are installed.

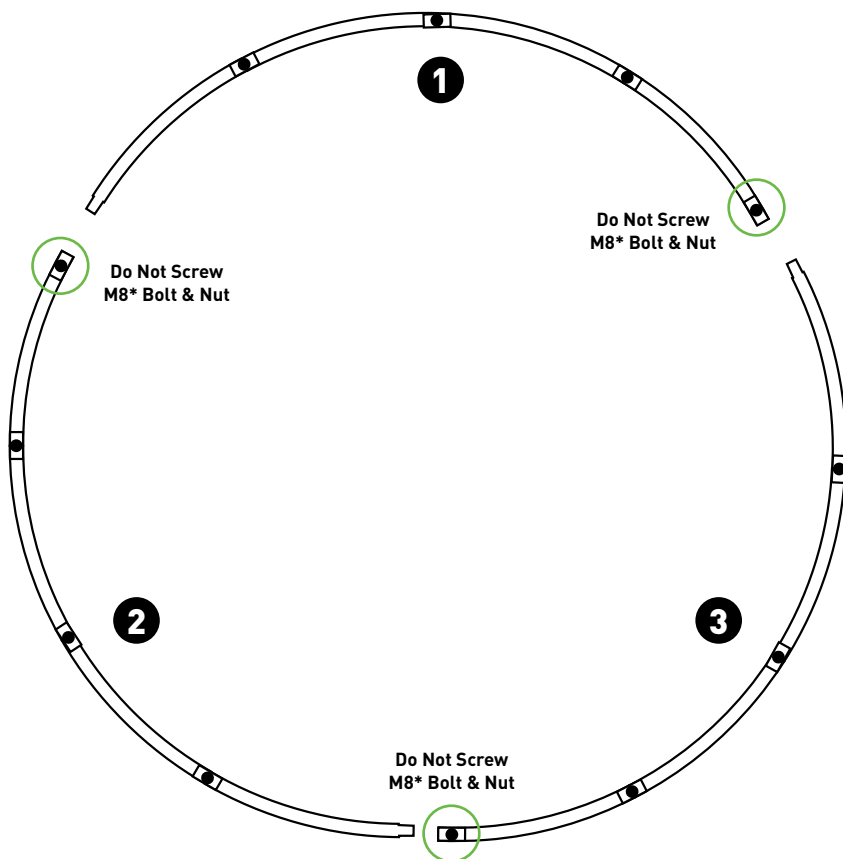

ASSEMBLY INSTRUCTIONS

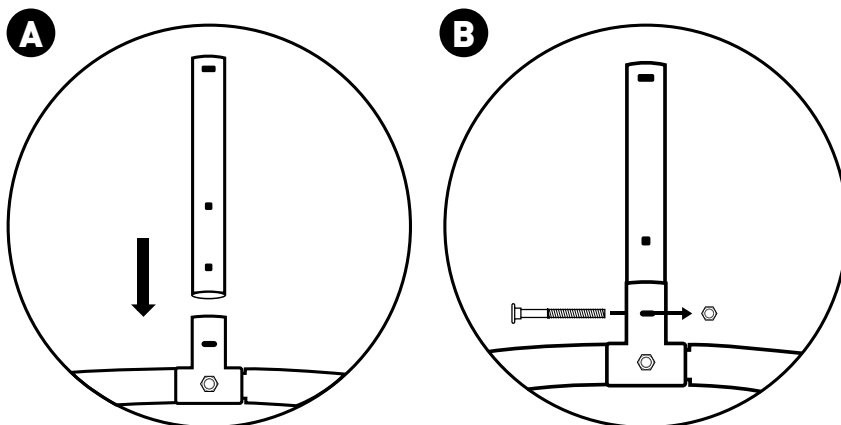

STEP 4:

A. Gather all Leg Extensions (Part 6) and begin inserting them into the T-Sections

NOTE:

The Leg Extension will have 3 openings. The 2 square openings closest to each other, will go inside the T-Section. Make sure that wider section is facing the center of the trampoline.

B. Use M6 Bolt & Nut (Part 5) to install the Leg Extensions to the body of the T-Section



IMPORTANT MESSAGE

WARNING - PLEASE READ

If you are installing the Pure Fun 12FT Trampoline Enclosure (Model# 9312TS - Enclosure) We recommend you install M6 (Part 5) loosely until you start the Owners Manual of the enclosure.

The bolt and nut will keep the trampoline attached safely until you finish installing it completely.

Once the trampoline is finished, the Bolt and screw will have to be removed in order to install the parts for the enclosure pole.

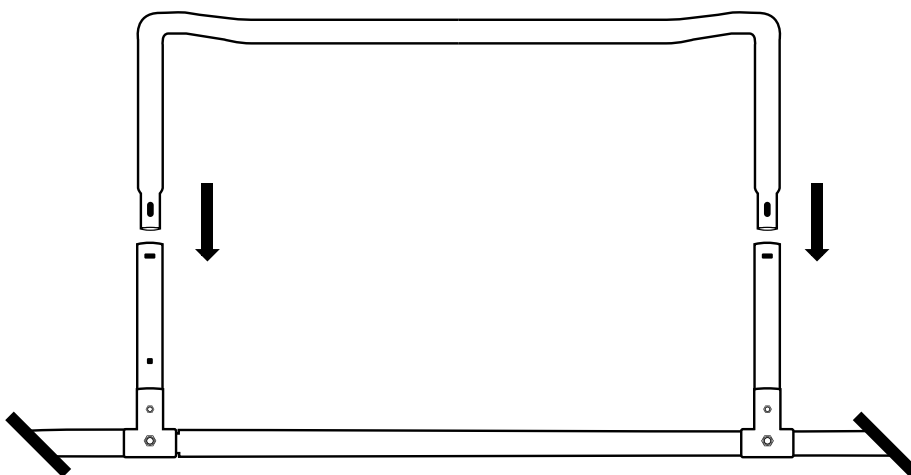

STEP 5:

Place the U-Shaped Legs (Part 7) on top of the extensions while keeping the openings facing the center of the trampoline.

If Step 4 has been followed correctly, you will be able to see both openings from the Leg Extension and U-Shaped Legs.

ASSEMBLY INSTRUCTIONS

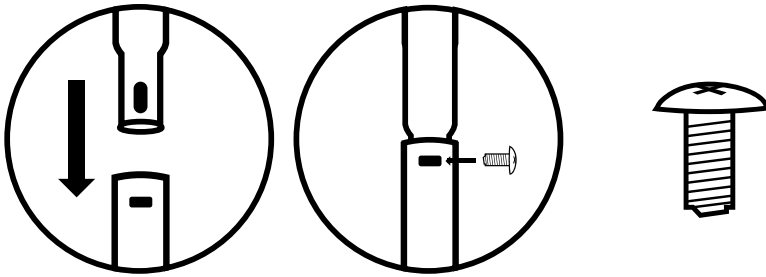

STEP 6:

Use the Screw (Part 8) with a Phillips screwdriver to secure the Leg Extension to the U Shaped Leg.

NOTE:

It is recommended to use a powered screwdriver to accomplish this task safely.

1

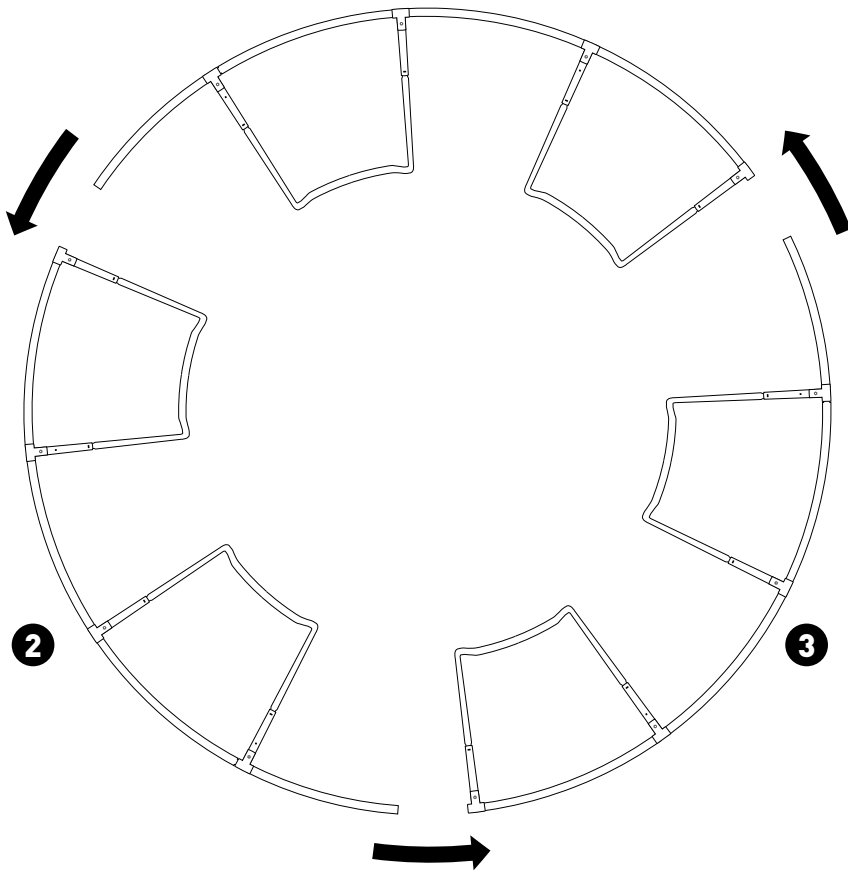

STEP 7:

Once all 3 groups have been successfully completed, flip them over so they may stand.

You may start connecting all ends to one another in order to complete the frame.

NOTE:

It is recommended that you use the help of 2 more adults in order to attach all groups together. The tension from the Top Rails might be too strong for one person to do by themselves.

Secure all 3 remaining T-Sections parts by screwing M8 Bolt (Part 4) with the Nuts facing toward the center of the trampoline.

The Frame of the trampoline should look like the illustration shown in Figure A

Figure A

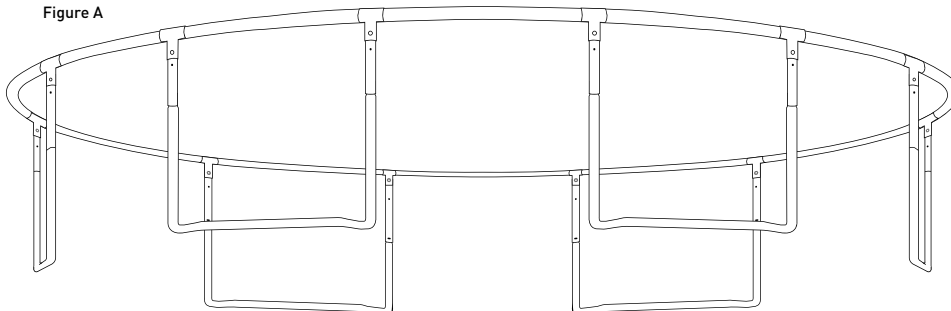

ASSEMBLY INSTRUCTIONS

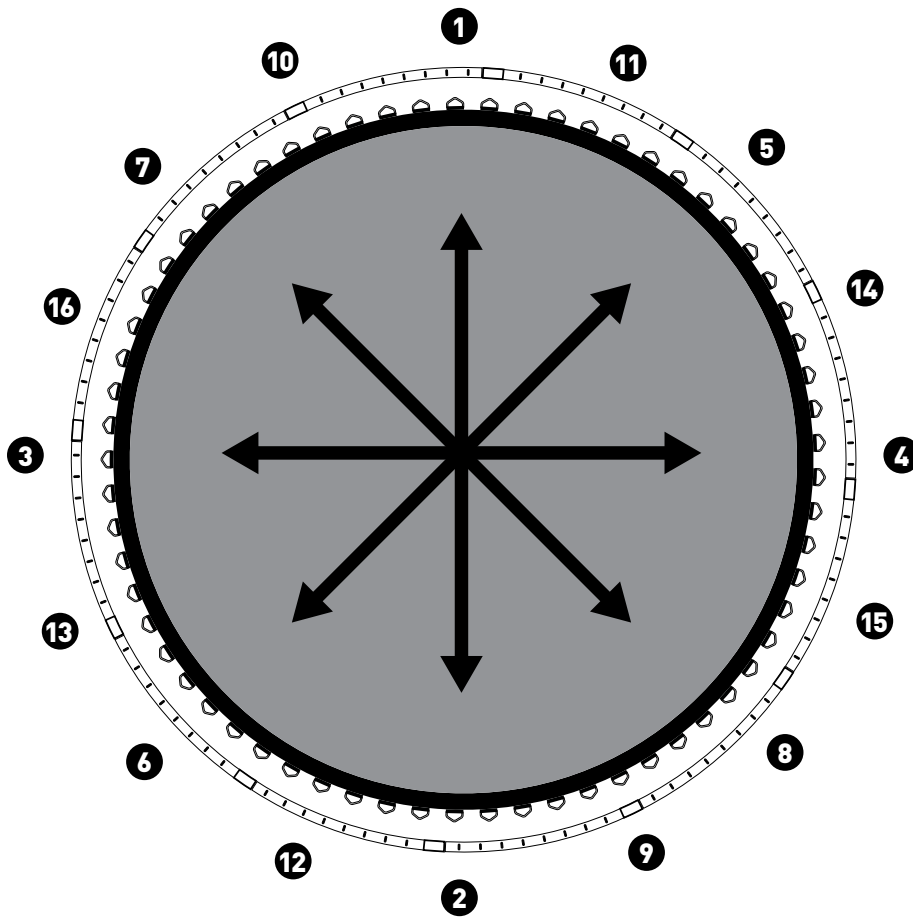

STEP 8:

Place the Jumping Mat (Part 1) in the middle of the frame and unfold it completely.

NOTE:

Make sure the stitching of the Jumping mat is facing the floor

In order to avoid ripping and to distribute tension when attaching springs to the frame, follow the numbered order shown.

Once a spring is attached to the Jumping mat, you must attach the other in the opposite direction of the mat.

Once the first 16 Springs (Part 9) have been placed, Attach all remaining Springs using the T-Hook that was provided clockwise.

NOTE:

Failure to use appropriate tools may result in injury or pinching due to tension of the springs. We recommend you use gloves when attaching springs to the frame.

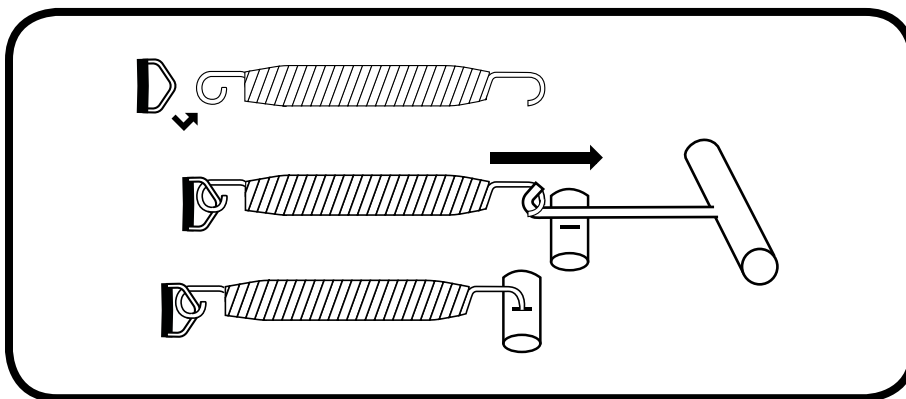

HOW TO USE T-HOOK:

In order to insert the spring properly, hook the curved end to the V-ring of the jumping Mat. Then, pull on the Long Round end with the T-Hook until it is attached on one of the corresponding openings of the Top Rail.

ASSEMBLY INSTRUCTIONS

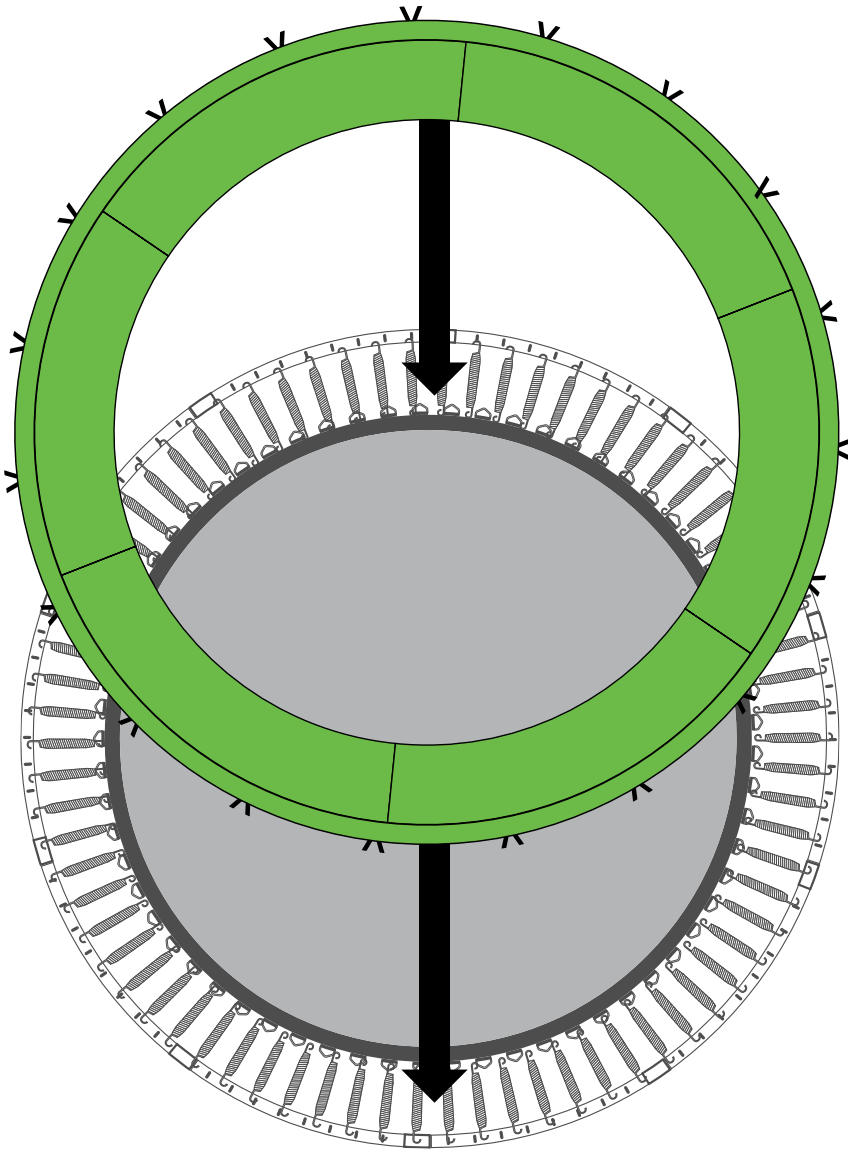

STEP 9:

Unfold the Frame Pad (Part 10) and place it on top of the Top Rail and springs. The skirt of the Frame Pad must cover the Top Rails completely to avoid injury.

NOTE:

Make sure the connecting straps are facing the Top Rails in order to secure the Frame Pad to them in Step 10.

ASSEMBLY INSTRUCTIONS

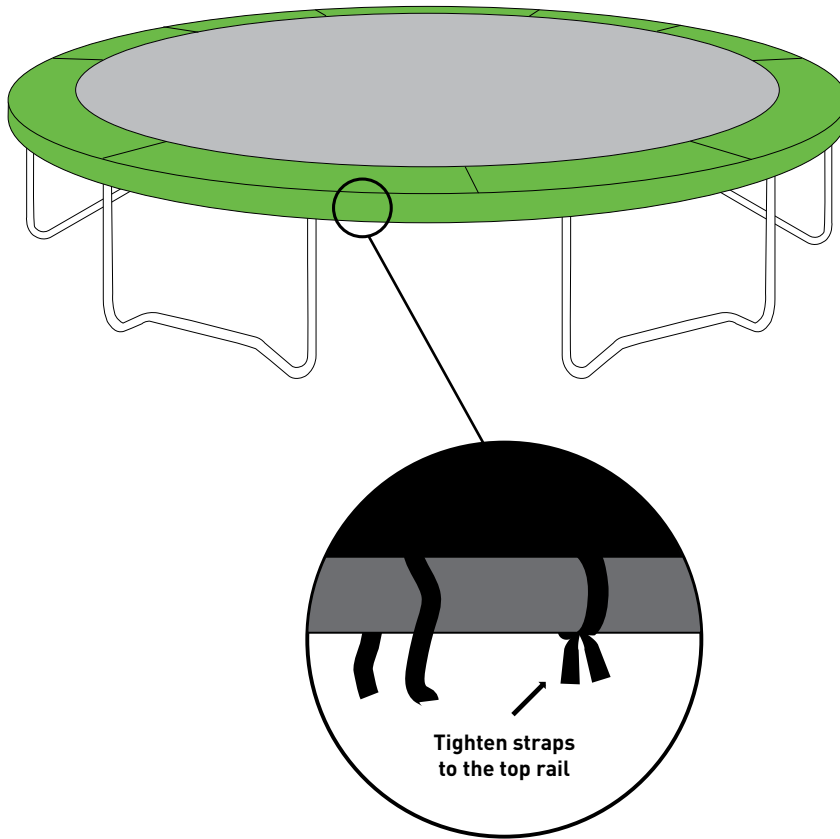

STEP 10:

Find all the bottom connecting straps of the trampoline frame pad and secure them by tying them in a not on to the top rails to avoid moving or shuffling when jumping on the trampoline.

FREQUENTLY ASKED QUESTIONS

- Question: "I need to mow the grass under my trampoline" or "I need to move my trampoline across the yard. What is the best way to do this?"

Answer: Once your trampoline is assembled, to avoid damage to the unit moving the trampoline requires that you tape the top rail frame joints to prevent slippage

Moving it over distanced requires that you use at least 4 adults places equidistant around the trampoline. Never drag or roll your trampoline in order to move it.

- Question: "My frame pad keeps shifting after just a few minutes of use. What can I do?"

Answer: You probable have you frame pad too tight. Re-seat the pad by taking it completely off. Remember: Do not try to stretch the Elastic Bans to their tightest point. The bands need some give as the jump mat they are attached to will move significantly when someone is jumping on the trampoline.

- Question: "Can I use any brand enclosure for my trampoline, or just Pure Fun?"

Answer: Enclosure designs are very similar, but there some specific dimensions like width between legs and springs size which can affect the circumference of the trampoline frame. As such, we cannot recommend another brand's enclosure Question: "Something was missing from the packaging," or "I discovered a damaged piece. What should I do?"

- Question: "I need to order springs" or "I need to order a new frame pad, who do I contact?"

Answer: If it has been 30 days or less from the date of your initial purchase, you can contact customer service (info below) for a replacement part to be issued.



DURA-BOUNCE 12FT TRAMPOLINE ENCLOSURE

MODEL# 9312TS
PRODUCT MANUAL - VERSION 01.18.05

FOR AGES:

6+

ADULT(S) NEEDED:



TOOLS NEEDED:



WARNING/ADVERTENCIA

- Do not allow more than one person on the trampoline at any time.
- Do not allow small children to use unless supervised by an adult.
- ADULT ASSEMBLY REQUIRED.
- The contents of this package are not suitable for children under 3 years of age. Contains small parts which may cause choking.
- Consult a physician before beginning any exercise program or strenuous activity.

CUSTOMER SERVICE

-  GQBrands.com
-  CustomerService@gqbrands.com
-  1-866-498-5269
-  4401 Samuell Blvd, Ste 150
Mesquite, TX 75149

CUSTOMER SERVICE INFORMATION

Thank you for purchasing:

DURA-BOUNCE 12FT TRAMPOLINE ENCLOSURE

MODEL# 9312TS

At Global Quality Brands®, we want all of our customers to be completely satisfied with their purchase. Please take time to review the contents of the product you have just received to make sure that all of the parts are included. If you find that any parts are missing or damaged, we will happily provide replacement parts at no charge within 30 days of purchase.

Please keep in mind that for select damaged part replacement requests, we will require a photo for submission.

If you request replacement parts, please be sure to include the following information in your correspondence:

YOUR NAME:

YOUR MAILING ADDRESS:

YOUR EMAIL ADDRESS:

PRODUCT NAME:

PRODUCT MODEL #:

PART # (Located In Manual)

RETAILER WHERE YOU PURCHASED PRODUCT:

DATE OF PURCHASE:

ORDER # (If Available)

SERIAL#:

QUANTITY NEEDED:

PICTURE OF DAMAGED PART(s) SUBMIT VIA Email, Fax, or Mail

To order these parts, or if you have any other questions or concerns about this GQBrands product, please contact us at

PureFun.net
Global Quality Brands®
Phone: 1-866-498-5269
Email: customerservice@gqbrands.com
4401 Samuell Blvd, Ste 150
Mesquite, TX 75149

Sincerely,
Customer Service

LIMITED WARRANTY

Global Quality Brands® warrants this product to be free from defects in workmanship and materials under normal use and conditions for a period of ONE YEAR FROM THE DATE OF ORIGINAL PURCHASE. This Limited Warranty is not transferable and is available only for the original purchaser of the Product. The Company's obligation under this warranty is limited to replacing or repairing the Product, at the discretion of the company.

All warranty coverage extends only to the original retail purchaser from the date of purchase, GQ Brands obligation under this warranty is limited to replacing or repairing, at Global Quality Brands® option. All products for which a warranty claim is made must be received by Global Quality Brands® and accompanied by sufficient proof of purchase (photocopy of the original store receipt, indicating the date of purchase). All freight and handling fees are the responsibility of the consumer to pay, both to and from Global Quality Brands®. All warranty claims must be preauthorized by Global Quality Brands® pre-authorization can be obtained by calling 866-498-5269.

This warranty does not cover ordinary wear and tear, weathering, failure to follow directions, improper installation, improper maintenance, or acts of nature, (such as damage caused by wind, lightning, snow, water, or ice) weather damage, damage caused by unauthorized repair work or damage caused by improper use of the products are not covered by the product warranty. No other warranty beyond that specifically set forth above is authorized by GQBrands®.

GLOBAL QUALITY BRANDS® IS NOT RESPONSIBLE OR LIABLE FOR INDIRECT, SPECIAL OR CONSEQUENTIAL DAMAGES ARISING OUT OF OR IN CONNECTION WITH THE USE OR PERFORMANCE OF THE PRODUCT OR OTHER DAMAGES WITH RESPECT TO ANY ECONOMIC LOSS, LOSS OF PROPERTY, LOSS OF REVENUE OR PROFITS, LOSS OF ENJOYMENT OR USE, COST OF REMOVAL, INSTALLATION OR OTHER CONSEQUENTIAL DAMAGES. SOME STATES DO NOT ALLOW THE EXCLUSION OR LIMITATION OF INCIDENTAL OR CONSEQUENTIAL DAMAGES. ACCORDINGLY, THE ABOVE LIMITATION MAY NOT APPLY TO YOU. THE WARRANTY EXTENDED HEREUNDER IS IN LIEU OF ALL OTHER WARRANTIES AND GLOBAL QUALITY BRANDS®, SPECIFICALLY DISCLAIMS ANY IMPLIED WARRANTY OF MERCHANTABILITY OR FITNESS FOR A PARTICULAR PURPOSE IS LIMITED IN ITS SCOPE AND DURATION TO THE TERMS SET FORTH HEREIN. SOME STATES DO NOT ALLOW LIMITATION ON HOW LONG AN IMPLIED WARRANTY LASTS. ACCORDINGLY, THE ABOVE LIMITATION MAY NO APPLY TO YOU. THIS WARRANTY GIVES YOU SPECIFIC LEGAL RIGHTS. YOU MAY ALSO HAVE OTHER RIGHTS, WHICH VARY FROM STATE TO STATE.

WHILE EVERY ATTEMPT IS MADE TO ENSURE THE HIGHEST DEGREE OF PROTECTION IN ALL EQUIPMENT, WE CANNOT GUARANTEE FREEDOM OF INJURY. THE USER ASSUMES ALL RISK OF INJURY DUE TO USE. ALL MERCHANDISE IS SOLD ON THIS CONDITION, WHICH NO REPRESENTATIVE OF GQ BRANDS® CAN WAIVE OR CHANGE.



IMPORTANT MESSAGE

WARNING - PLEASE READ

ADULT ASSEMBLY REQUIRED

CHOKING HAZARD - Small Parts

NOT for children under 3 years of age.

WARNING:

While every attempt is made to ensure the highest degree of protection in all equipment, we cannot guarantee freedom from injury. The user assumes all risks of injury due to use. All merchandise is sold on this condition, which no representative of the company can waive or change.

WARNINGS

Please read these warnings and the information in this manual in its entirety.

Failure to comply with the following instructions may increase the risk of serious injury and/or death:

- Ensure the trampoline has been assembled correctly, per the instructions in the manual.
- It is essential that the intended site for this trampoline is completely flat and level. If the ground is not level this will cause movement in the frame and could cause stress on the joined sections.
- Before each use of this product, inspect the entire assembly and replace any worn, defective or missing parts.
- It is only recommended for use by children 6+ years of age.
- DO NOT allow more than one person on the trampoline at a time.
- DO NOT wear glasses or helmets when using the trampoline.
- DO NOT use the trampoline in wet, windy or other adverse weather conditions. Use only when the trampoline mat is clean, dry, and safe of obstructions.
- DO NOT somersault or perform flips. This can cause serious injury, resulting in paralysis or death.
- DO NOT use the trampoline as a springboard to or from other objects. NEVER jump from or attempt to jump to other objects, bodies of water, buildings or surfaces, or into or over the trampoline enclosure.
- DO NOT allow other persons to go under, sit, stand or lie on the trampoline or the frame pads while the trampoline is in use.
- DO NOT use the trampoline set when under the influence of alcohol, drugs or medication which may impair the jumper's judgment and coordination.
- ALWAYS remove jewelry, belt buckles or any other sharp objects before using the trampoline.
- ALWAYS jump in the center of the trampoline mat.
- ALWAYS secure the trampoline against unauthorized and unsupervised use.
- NEVER wear footwear (e.g. shoes) when using the trampoline. ALWAYS wear socks when using the trampoline.
- Children MUST NEVER use the trampoline unless supervised by a responsible adult with knowledge of trampoline use.
- Children MUST NEVER be left unattended at any time.
- Ensure the trampoline set is on level ground with a minimum of 8 feet (2.5M) clear space around the sides, 26 feet (8M) clear height space above and that no obstructions are under the trampoline.
- ALWAYS watch for power lines, overhead cabling, and other hazards or obstructions above, around and below the location where you are installing your trampoline set. Failure to do so can result in serious injury, death, and property damage.
- Mount and dismount from the trampoline and enclosure with care as injury may result. Children should be assisted when entering and exiting the trampoline to reduce the risk of falling.
- The frame of your trampoline set is made of steel and it will conduct electricity. No electrical equipment (lights, heaters, etc.) should be permitted on or around the trampoline under any circumstance.
- Please read and refer to other warnings and use information in the trampoline instructions before use.
- Dispose of all packaging materials safely and per local ordinance. This Safety
- Net and Enclosure is ONLY intended to help prevent accidental falls from the trampoline mat/bed.
- This Enclosure is designed and made for family domestic use only by people 6 years and older. It is not a rebounding device. It is designed only to assist in controlling entry to the trampoline and allowing trampoline jumpers to gain confidence, balance, coordination and agility by providing the added safety of an enclosed jumping area.
- Never use an Enclosure for anything other than its intended purpose.
- It is the responsibility of the supervisor(s) of trampoline and Safety Net users to provide knowledgeable and mature supervision. They need to know and enforce all the rules and warnings set forth in both the Trampoline and Safety Net manual in order to minimize the likelihood of accidents and injuries and to inform users of these rules.
- During periods of time when supervision is unavailable or inadequate, this may require that the Trampoline and Safety Enclosure be disassembled, placed in a secure area, or otherwise secured against unauthorized use. It is the responsibility of the supervisor(s) to be sure that the users are fully aware of the safety guidelines.

ASSEMBLY WARNINGS

- The minimum overhead clearance required is 26 feet (8 meters). Ensure that no hazards or obstructions are near the trampoline such as tree branches, swing sets, swimming pools, electrical power wires, walls, fences, roof overhangs etc.
- Please be aware of the following when selecting a place for your trampoline:
 - Trampoline must be placed on a level surface.
 - All obstructions from overhead, underneath or around the trampoline must be removed.
 - Do not use this trampoline indoors.
 - Do not use this trampoline on any slippery/smooth floor surface, uneven or sloping ground surface.
 - Do not place the trampoline on hard surfaces, such as asphalt, stone, concrete etc, as this can damage the frame.
- You increase the risk of serious injury and/or death if you do not follow these guidelines.
- The area must be well lit.
- When you are ready to start, make sure that you have the correct tools at hand, and adequate space for assembly.
- Please refer to the table for part descriptions and numbers. The assembly instruction uses these descriptions and numbers as reference. Make sure you have all parts listed. If you are missing any parts, please contact our customer service.

PARTS LIST

Part #	Description	QTY	Part#	Description	QTY
1	Straight Enclosure Pole	x6	6	Washer	x12
2	Curved Enclosure Pole	x6	7	Nut	x12
3	Enclosure Pole Cap	x6	8	Black Cap Nut	x12
4	Screw	x12	9	Enclosure Net	x1
5	Spacer	x12	-	-	-

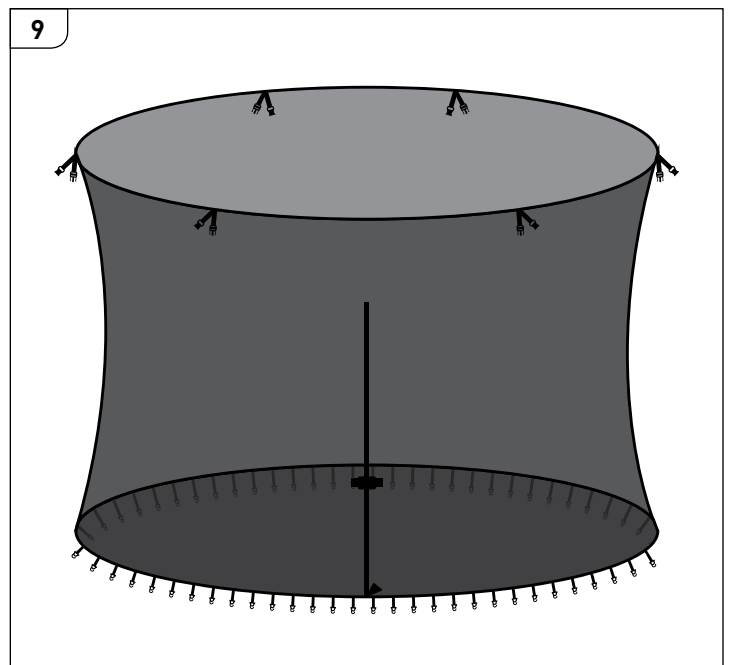
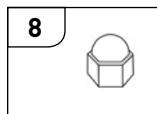
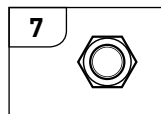
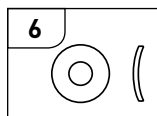
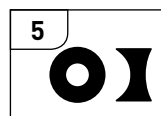
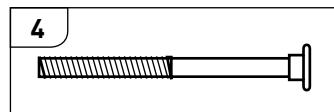
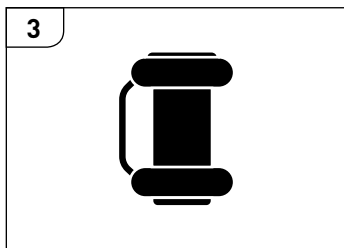
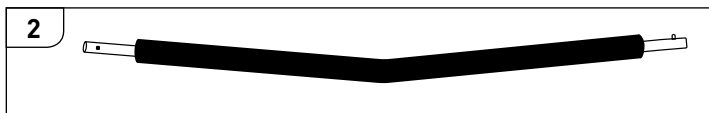
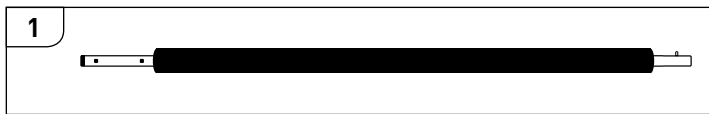

ASSEMBLY INSTRUCTIONS

STEP 1:

Gather all Curved Enclosure Poles (Part 2) and Enclosure Pole Caps (Part 3).

IMPORTANT:

Do not attach the Enclosure Pole Caps to the Straight Enclosure Poles. Once an Enclosure Pole Cap has been installed **it cannot be removed.**

Snap and click all Enclosure Pole caps to the Curved Enclosure Pole. The button must be pushed down, and you will hear a click once successfully attached.

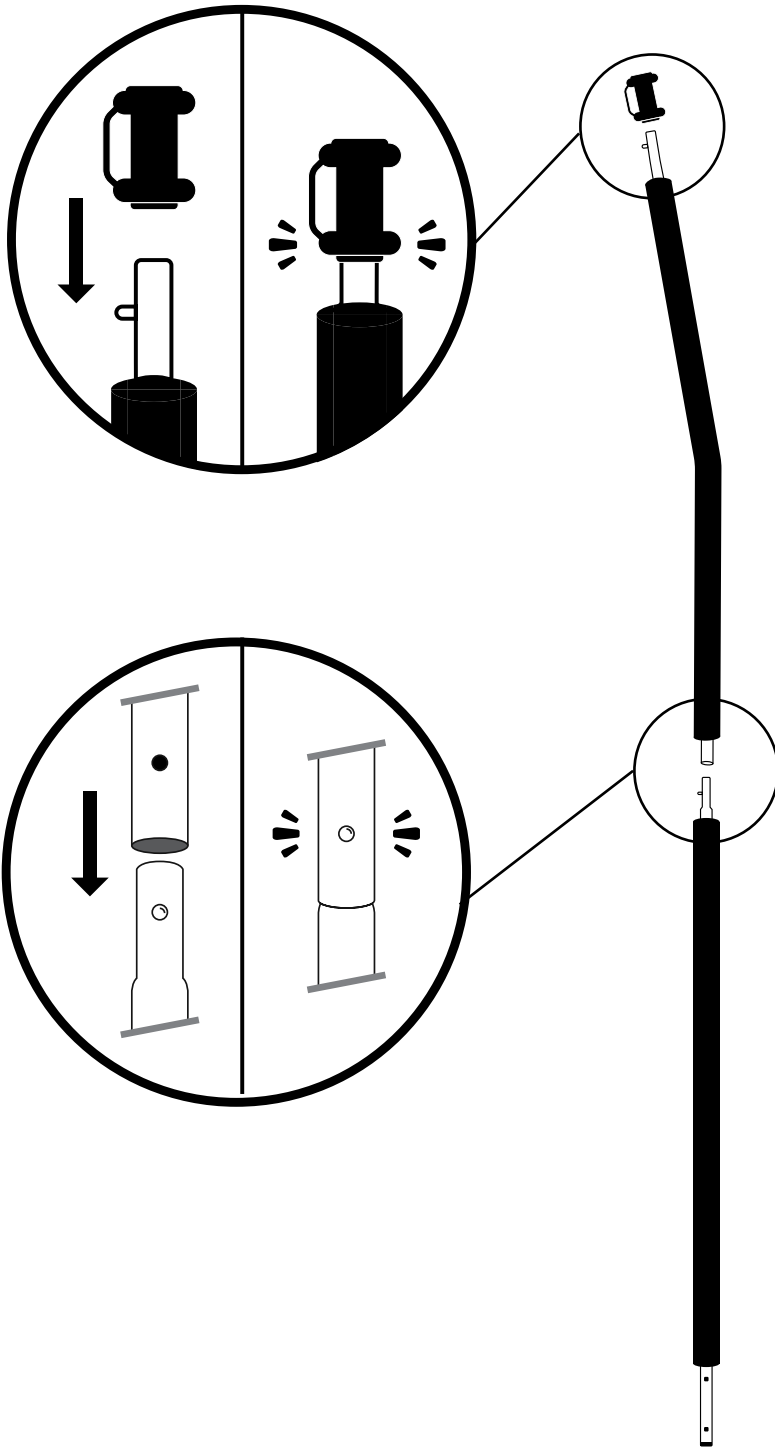

STEP 2:

Collect all Straight Enclosures Poles (Part 1)

Connect the Straight Enclosure Poles and Curved Enclosure Poles using the Snap and Click mechanism. Button must be pushed down, and you will hear a click once successfully attached.

You will have 6 completed Enclosure Poles.

ASSEMBLY INSTRUCTIONS

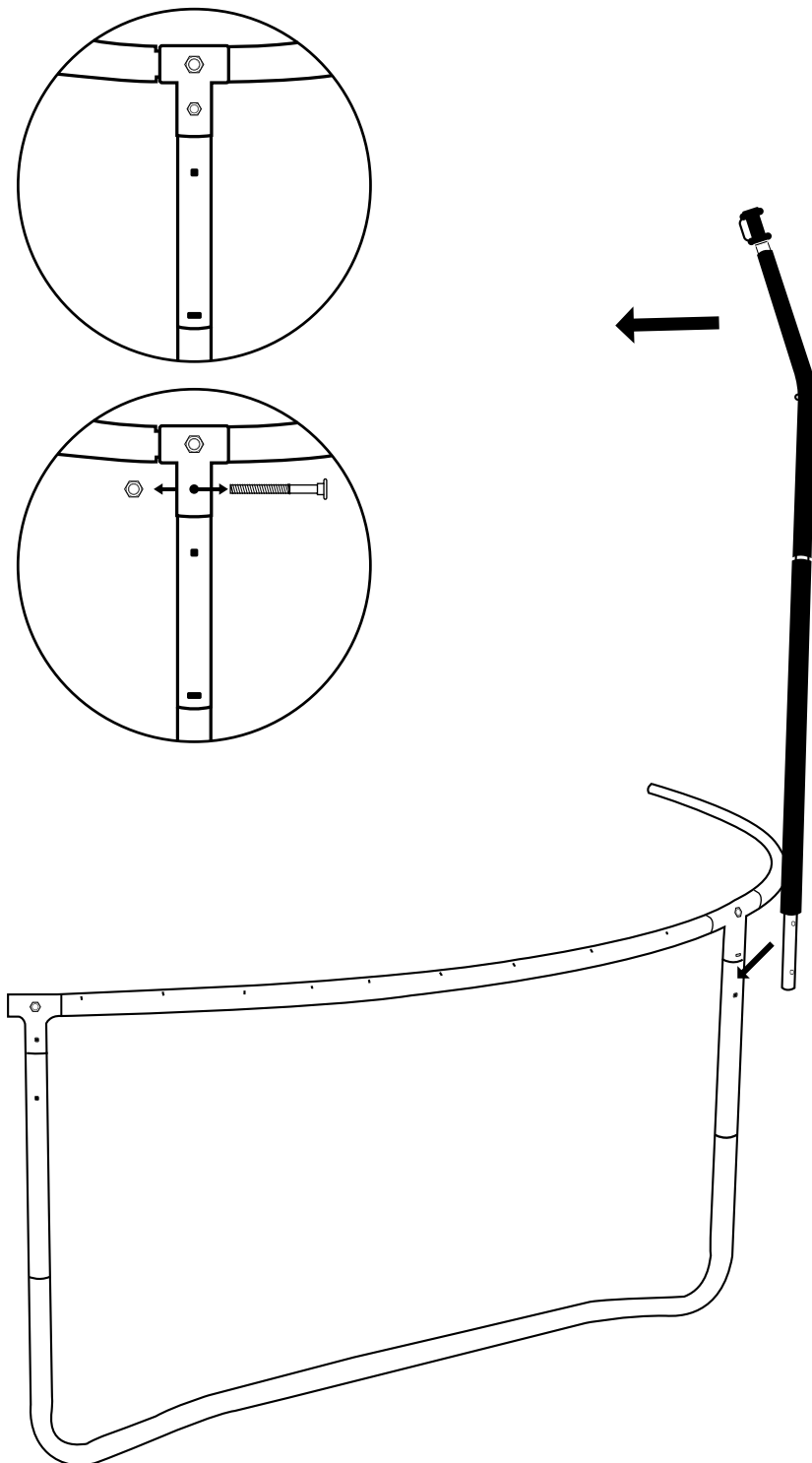

STEP 3:

- A. Remove the Nut and Screw from 12FT Enclosure Trampoline on the right side of the U-Shaped Leg.

Do not remove all nuts and bolts at the same time, only 1 set a time to keep the strength of the Frame at all times.

NOTE:

Make sure to keep removed parts stored or in a safe place away from the mat while building the Enclosure.

- B. With the help of another adult, hold the completed enclosure pole by aligning both square holes to begin installation.

NOTE:

Curved Enclosure Pole must face the center of the trampoline.

- C. Once aligned, screw in the completed pole to the leg. Follow the directions on the next page (Page 10) for the order and right parts to attach properly

- D. Continue to do this on all U Shaped Legs one by one until you ave installed all 6 Enclosure poles tightly.

ASSEMBLY INSTRUCTIONS

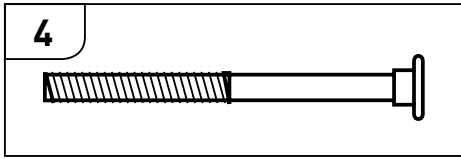

Screw

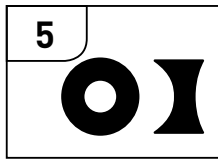

Spacer

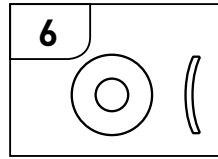

Washer

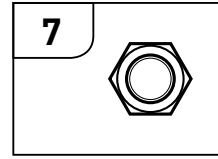

Nut

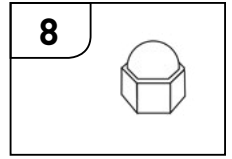

Black Nut Cap

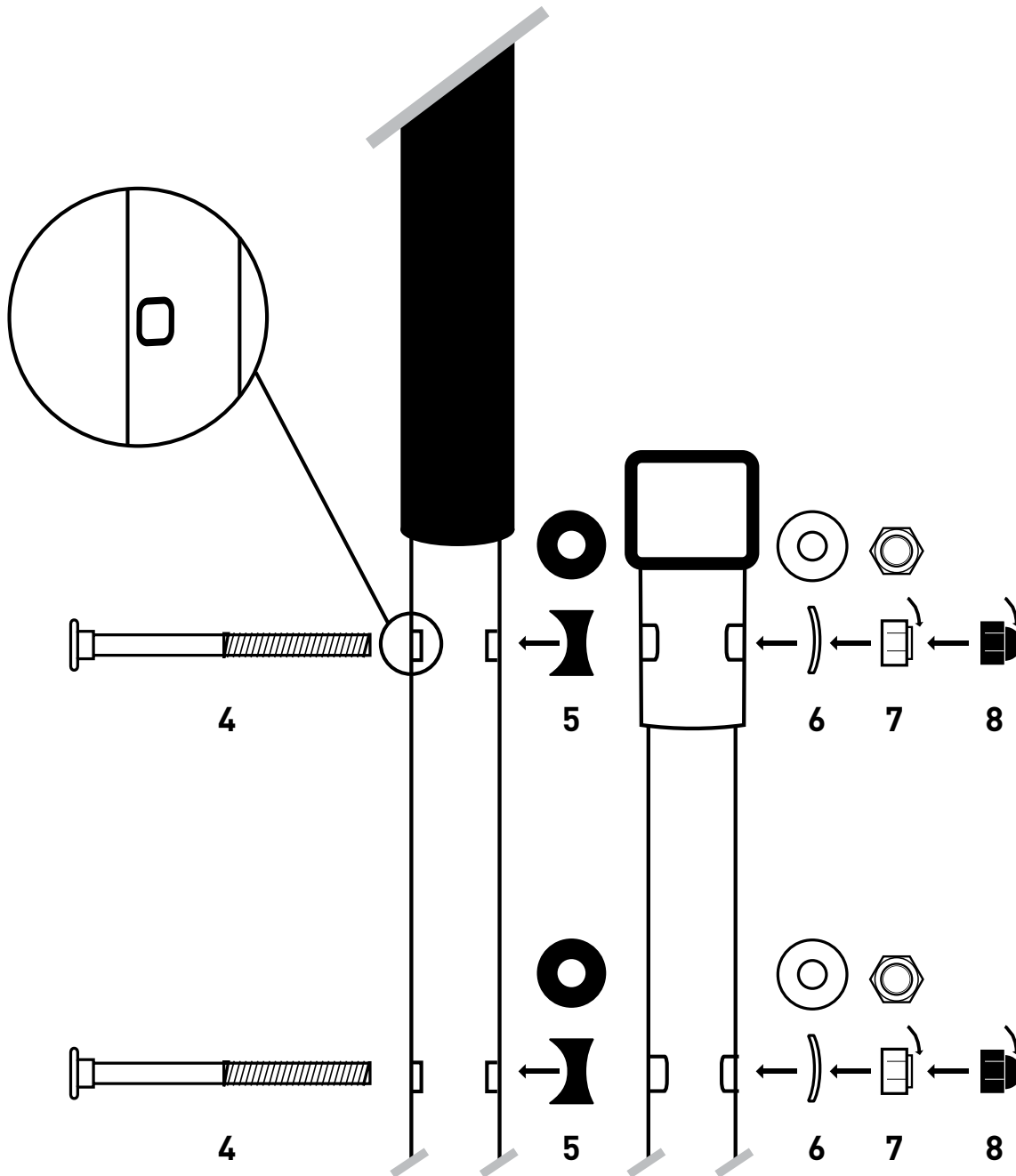

ASSEMBLY INSTRUCTIONS

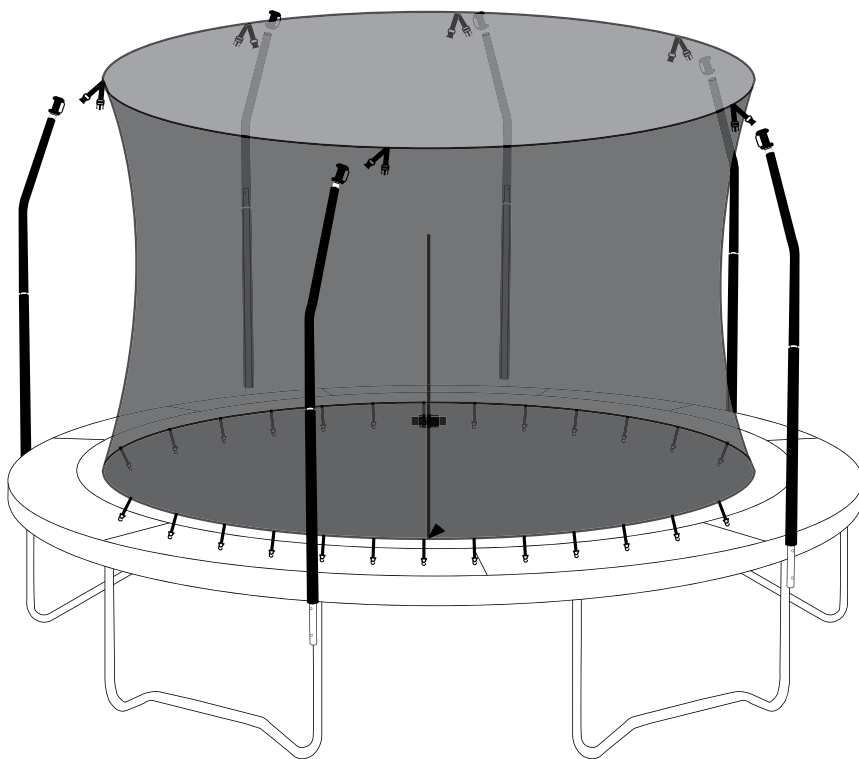

STEP 4:

Place the Enclosure Net (Part 9) on top of the trampoline. Align the straps to the corresponding Enclosure Poles so they are as near to each other as possible when lifted

NOTE:

Make sure that zipper and buckle snap are facing the outside of the trampoline. This is good to ensure that Enclosure is not reversed.

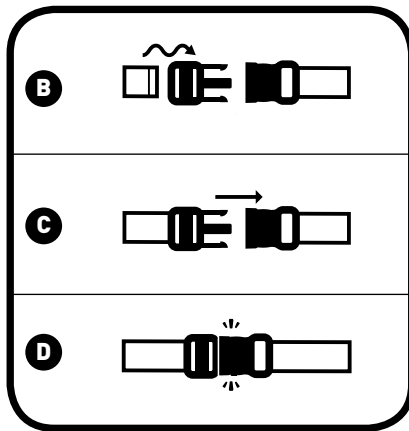
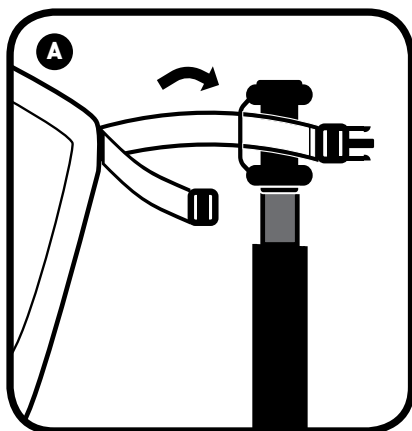

STEP 5:

- A. To attach the enclosure net to the Pole Caps, grab the corresponding strap at the top of the Enclosure Net and slip through the opening of the Pole cap.
- B. If the Male Buckle Snap (Fork Side) to the strap, make sure to fasten into strap before inserting through the Cap
- C. Once Male Buckle snap is fastened, Attach to the other side of the buckle.
- D. You will successfully connect both sides when you hear them click.

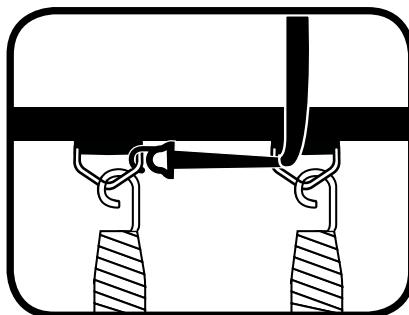
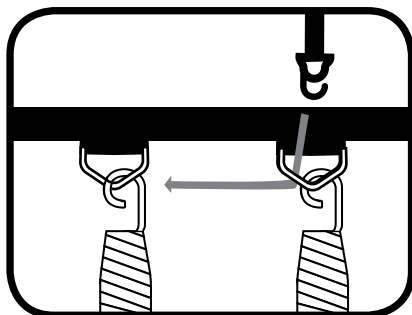

STEP 6:

To keep the net attached to the Jumping Mat, slip the hooks at the bottom of the Enclosure Net through the nearest V-Ring slot, and hook to an adjacent V-Ring as shown.

Continue to do this until all hooks on the enclosure are attached in this way.

FREQUENTLY ASKED QUESTIONS

- Question: "I need to order a new net" or "I need to order replacement poles or other replacement parts, who do I contact?"

- Answer:
You can purchase springs, frame pads, jump mats, and many more parts directly from Pure Fun. You can contact customer service (info below) or visit our website:
PureFun.Net

- Question: "Something was missing from the packaging," or "I discovered a damaged piece. What should I do?"

Answer: If it has been 30 days or less from the date of your initial purchase, you can contact customer service (info below) for a replacement part to be issued.